



world**stainless**  
Stainless Steel  
Industry Awards 2024  
Technology  
Silver Award

world**stainless**  
Stainless Steel  
Industry Awards 2024  
Sustainability  
Gold Award

Stainless Steel Industry  
Awards 2024



## Table of contents

### Market Development Case Studies

Gas Turbine Regenerator Heat Exchanger Cores  
Louvered Pipe for Ground Water Applications  
Stainless steel coastal fencing solution  
E-Line Economisers  
EW-Pellets  
Gas Turbine Exhaust System  
Honjo River Tsunami Gate  
Twin-biomass  
Round-dot patterned stainless steel plate enables smooth operations with roll box pallet

### Technology Case Studies

Development of Water-Soluble Belt Grinding Oil for Coil Grinding lines  
Austenitic Stainless Steel with High Strength and Cryogenic Toughness for Liquefied Hydrogen Environment  
High Conductive Ferritic Stainless Steel for Solid Oxide Fuel Cell Separator  
Automatic Surface defects inspection for angle packaging line

### Safety Case Studies

SP2 Work Roll Jog from Polisher Control Station  
Global Machinery Safety Roadmap  
Grinding Wheel Tilting  
Real time Hot metal driver monitoring  
Crane Hook Safety Latch  
Jig for changing press roll at ZM



Keep Door Closed Strategy

Slab Cutter Access Control

AOD emergency recovery device

Ti drum lifter and feed chute

Colour and sign signalling to improve identification of overhead crane movements

Truck load securing chain checkers

Portable Lifelines for load securing and tarping

Design and implementation of a new tool for the ignition of thermal lances

Design and installation of a decontamination cabin at acid recovery plant

PackSolve Plate Lifters Safety Improvement

Improvements in material movements: poles to avoid touching material with hands

V-belt Drive-train Manipulating Tool

Inversed placements of bolt and nut : Improvements for electrode replacement work in sulfuric acid electrolysis tank

### **Sustainability Case Studies**

Seal Water Improvements and Reuse

Chemical tankers using SUS329J1(NSSC™2351)

The Shikishima Water Tower, Maebashi, Gunma

Oil Removal from Alkali Rinse

Sustainable Packing Material For Continual Re-use

Using used plastic buckets for cultivating crops

Using Used Slab Grinding Wheels for land stabilisation

Equipment to recover soap used as lubricant in stainless steel drawing.

Reduction of environmental pollution in external areas of Steel Plant





## Introduction

All companies supplying case studies for the application awards had to answer the following questions:

### The Challenge

What problem were you trying to solve or what feature were you trying to develop?

### Why?

Why did you decide it was necessary to address this challenge?

### Needed Action

What action(s) did you take to solve the problem or undertake the development?

### Action Review

Were the action(s) taken SMART? Specific, Measurable, Achievable, Realistic and Time-bound

### Target Beneficiaries from the Action

Who are the people, organisations and/or communities who have benefited from the outcome of the above action? (e.g.; host company, employees, contractors, local community, regional community, customers, global community, etc.)

### Horizontal Expansion Capability

Can the actions or approach taken be expanded for use elsewhere within your company and/or applied within other member companies?

### Outcome

What benefits have you observed and quantified since you took the action? Please also explain the value of each of the stated benefits to employee health and well-being, job satisfaction, leading indicators (KPIs) and lagging indicators (KPIs).

We hope the case studies will give inspiration to other member companies worldwide.

The worldstainless Team





# Market Development Case Studies



## Gas Turbine Regenerator Heat Exchanger Cores

### Member company

**North American Stainless**

### Challenge

The customer wanted to build Gas Turbine Regenerators designed to increase the efficiency of Gas Turbines by recovering waste heat from exhaust gases. The material needed for the internal cores of the heat exchanger had to have proven corrosion resistance at elevated temperatures.

### Why?

The corrosion of the heat exchanger cores would limit the life of the regenerators as well as increase the maintenance and replacement costs.

### Needed action

T409 stainless steel produced at North American Stainless was provided by the company Straub Metals to the Manufacturer of the Regenerators “Pal-Con Ltd” as the optimal material to be used due to the corrosion resistance exhibited at higher temperatures thus being less susceptible to stress corrosion and fatigue cracking.

### Action review

*Specific:* Various metals were studied and tested, with T409 being the best alternative both for corrosion resistance and price.

*Measurable:* Corrosion resistance of T409 used can be measured over time by means of inspection and amount of maintenance required.

*Achievable:* Initial objectives to find the



best material for the use in the heat exchanger cores was achieved with the adoption of NAS grade T409.

*Realistic:* Actions were realistically achieved.

*Time-bound:* Actions were achieved within the required time frame.

### Horizontal Expansion Capability

The use of T409 for this application can be expanded to other companies manufacturing similar Regenerators.

### Outcome

Benefits include solid sales of Regenerators as customers can verify that the material used in the manufacturing achieves the intended purpose.





## Louvered Pipe for Ground Water Applications

### Member company

**North American Stainless**

### Challenge

Manufacture louvered/screen pipe for ground water wells with minimal corrosion.



### Why?

Due to the location of the pipes, in many cases deep underground, the pipes used had to be corrosion resistant as well as with optional strength.

### Needed action

Use of stainless steel in the manufacturing of the louvered pipe.

### Action review

*Specific:* After a study of various materials for the fabrication of pipe, stainless steel T304L was selected as the best option.

*Measurable:* T304L corrosion resistance can be measured with a number of specific tests to mimic the conditions surrounding the pipe, i.e. salt water spray test.

*Achievable:* The objective of manufacturing a louvered pipe with enhanced corrosion resistance was achieved by the use of T304L as the material of choice by the company Roscoe Moss in California, USA.

*Realistic:* The same results in corrosion resistance for this application can be replicated in other instances in which the need for corrosion resistance louvered pipe is a priority in ground water wells.

*Time-bound:* Manufacturing louvered pipe

in NAS grade T304L can be completed within required timeframe due to reliable supply of stainless steel by NAS.

### Horizontal expansion capability

The use of T304L for Louvered Pipe manufacturing can be expanded to other pipe customers.

### Outcome

The customer is satisfied with the results achieved by using NAS T304L grade for the manufacture of louvered pipe for ground well applications.

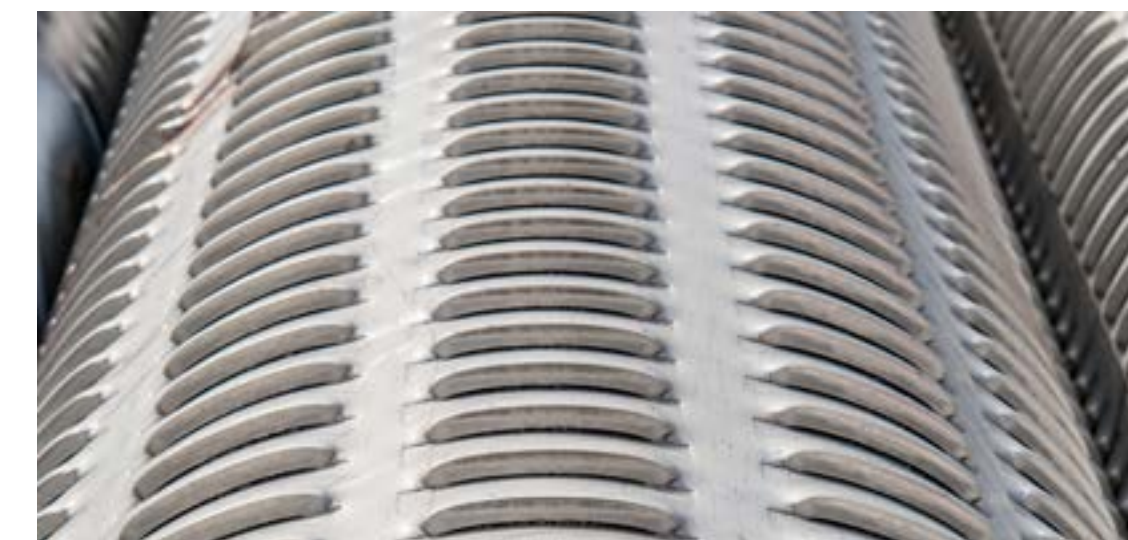



# Stainless steel coastal fencing solution

## Member company

**Australian Stainless Steel Development Association**

## Challenge

ASSDA Member **Stainless Steel Wire & Mesh** played a pivotal role in delivering a stainless steel coastal fencing solution that has now become the gold standard in ecological management and restoration efforts.

Situated in the Northern Beach of New South Wales, Australia, Curl Curl Beach faces the full force of several coastal conditions, enduring relentless assaults from strong winds, salt movements, extreme temperatures, pollution, and high humidity. This region is classified as a corrosive category C5, however the location which is adjacent to the beach has

been classified as CX under AS 4312:2019 Atmospheric corrosive zones, Figure 2.1 (Newcastle region). This beach demands infrastructure that can withstand nature’s harshest elements.

## Why?

Australian coastal environments present formidable challenges for infrastructure due to their exposure to corrosive, abrasive, and humid conditions. Recognising these challenges, the Northern Beaches Council engaged Toolijooa Environment Restoration with the critical task of designing and installing a 450m coastal fence on Curl Curl Beach. The objectives were clear:

- A minimum 15-year lifespan without replacement
- Minimal maintenance in the initial five years

- Mitigation of sand movements within the dune systems
- Restriction of access to both dogs and people

This application has been typically specified using galvanised steel products, however, the opportunity for stainless steel emerged as the material of choice for this demanding application due to its superior tensile strength, corrosion resistance, and unparalleled longevity. In comparison to surface-treated galvanised steel products, stainless steel offers extended asset life and lower maintenance requirements, reducing inspection frequency and overall costs. The table below delivers a details comparison.

Material/coating	Typical service life**	Average degradation rate (10 <sup>-6</sup> M/year)	When maintenance is required
316 stainless steel	720 years	0.025	Minimal maintenance due to washing from rainwater
Mild steel with hot dipped galvanised	2-6 years	6	From 4 years

*Reference: Whole of Life Cost Comparison and Cost Benefit Analysis for Steel Structures Constructed in the Foreshore Zone, Griffith University, 2009.*

\* Corrosivity zones in line with ISO9223

\*\* Table 16.2 Corrosion protection methods

# Table 16.1 Average degradation rates

^ 575g/m<sup>2</sup> in line with requirements of AS 4534 Zinc and zinc/aluminium-alloy coating on steel wire







## Needed action

ASSDA Member Stainless Steel Wire & Mesh, an innovator in converting galvanised wire applications to stainless steel, supplied its 'Strong Lock' product in grade 316 to meet the stringent requirements of the 700mm high coastal fencing. Notably, the Northern Beaches Council has now adopted stainless steel as the default specification for their coastal

fencing needs.

Adam Burrows, Special Projects Officer for the Northern Beaches Council, affirmed the significance of choosing stainless steel: *"Stainless Steel Strong Lock has been vital in our dune restoration works. Today, we aim to build structures that will outlast and endure into the future, minimising works for future generations. Galvanised steel wire cannot guarantee this in windy, sandy, and high salt environments."*

## Action review

**Specific:** The action taken was specific in addressing the need for a durable coastal fencing solution at Curl Curl Beach, facing extreme environmental conditions, including high winds, salt movements, extreme pollution and high humidity. The objective was to design and install a 450m, 700mm high coastal fence to

withstand these conditions, mitigate sand movements within the dune systems, and restrict access to both dogs and people.

**Measurable:** The success of the action can be measured through:

- Lifespan: A minimum 15-year lifespan without replacement was set as a measurable target.
- Maintenance: Minimal maintenance in the initial five years was identified as a measurable goal.
- Degradation rate: Degradation rates for different materials/coatings were measured and compared, with stainless steel demonstrating significantly lower degradation rates over time.

**Achievable:** The project objectives were achievable based on the selection of

stainless steel as the material for coastal fencing. Stainless steel was chosen for its proven durability, corrosion resistance, and longevity, making it a feasible choice for the challenging coastal environment of Curl Curl Beach.

**Realistic:** The action taken was realistic given the available resources, expertise, and technology. Stainless steel, as a widely available and proven material, made the project realistic in terms of implementation and maintenance.

**Time-bound:** The project has clear time-bound objectives, including:

- Design and installation of the 450m coastal fence within a specific timeframe.
- Maintenance goals set for the initial five years to ensure the longevity and effectiveness of the fencing solution.



- Lifespan target of a minimum 15 years, indicating a specific timeframe for the expected durability of the infrastructure.

### Horizontal Expansion Capability

The approach and actions taken in implementing stainless steel coastal fencing at Curl Curl Beach possesses significant potential for horizontal expansion not just for ASSDA Member Stainless Steel Wire & Mesh, but for application across the local and global industry. The success of this project lies not only in its specific application at Curl Curl Beach but also in its broader implications for coastal infrastructure and environmental management.

The expertise gained from designing, supplying and installing stainless steel coastal fencing can be leveraged for similar

projects in other coastal regions. Stainless steel solutions can be offered for a range of coastal infrastructure needs, including fencing, boardwalks, handrails and signage to name a few, ensuring durability and longevity in harsh marine environments. The knowledge and experience gained from this project can inform future product development and innovation initiatives to further enhance the performance and sustainability of stainless steel solutions for coastal applications.

The project delivers valuable insights and best practices for implementing similar solutions in respective regions. Industry collaboration can facilitate the exchange of knowledge, expertise, and resources to address common challenges related to coastal infrastructure and environmental management. By promoting the adoption of stainless steel solutions, we can



collectively contribute to enhancing the resilience and sustainability of coastal communities worldwide, aligning with broader industry objectives and initiatives.

### Outcome

**Business efficiency:** Reduced maintenance downtime allows employees and industry to focus on more productive tasks, leading to higher job satisfaction and morale, and

enhancing overall business efficiency. Demonstrating the longevity and durability of stainless steel solutions enhances the company and industry reputation, which can lead to increased sales through positive client feedback.

In addition, engaging in environmentally sustainable practices and contributing to environmental efforts can boost employee and industry satisfaction due to its positive impact.

Having a council adopt stainless steel as the default specification for this specific application sets a standard and can influence other councils and asset owners to review their materials selection for future projects.

**Cost:** Lower maintenance costs contribute to cost savings over the lifespan of the infrastructure, improving the client's





bottom line. In addition, long-term environmental benefits, such as improved ecosystem resilience and reduced erosion, can translate into cost savings.

**Material quality:** Stainless steel coastal fencing has demonstrated a lifespan of at least 15 years without replacement, significantly surpassing alternative materials. Stainless steel's resistance to corrosion ensures consistent material

quality over time, maintaining the integrity and aesthetics of the coastal fencing.

Using sustainable materials aligns with consumer preferences and expectations, enhancing the perceived quality of company products and stainless steel as a material. By choosing stainless steel, the project aligns with the principles of a circular economy by prioritising durable, long-lasting materials that can be reused, recycled, or repurposed at the end of their life.

### Other comments

Australian councils are increasingly recognising the whole-of-life cost considerations in material specifications for extended life and minimal maintenance. In 2009, a whole-of-life cost comparison report was published by Griffith University and the Gold Coast



City Council that investigated multiple scenarios from the perspective of what would represent the most cost-effective solution for structures in the foreshore zone with a design life greater than 19 years when comparing hot-dipped galvanised steel, paint systems, duplex systems using both HDG and paint, or stainless steel. The study revealed that stainless steel was the most viable option

based on cost alone. Please see the following link for a copy of the report: <https://www.assda.asn.au/images/PDFs/Final%20Reportr.pdf>

In the case of coastal fencing, stainless steel not only delivers improved financial performance but also enhances services and output.

Coastal fencing, often overlooked, plays a critical role in environmental conservation by facilitating dune restoration and protecting and rehabilitating local vegetation to enhance natural recovery. Stainless steel, with its unparalleled attributes, contributes significantly to maintaining and re-establishing a sustainable and diverse natural ecosystem. As this project exemplifies, stainless steel is not just a material, it's a guardian of our coastal heritage and a promise for a resilient and enduring future.



## E-Line Economisers

### Member company

**Acerinox Europa**

### The Challenge

Generally, traditional heat exchangers have low system efficiency, high energy and economic costs, difficult installation and high maintenance.

### Why?

Covering a wide range of boiler sizes, the E-Line delivers real energy and cost savings for commercial and industrial installations. In principle the E-Line economizers act as air to water heat exchangers. Flue gas, typically considered wasted heat, can be effectively cooled down and condensed through the AIC system. This cooling and condensing process releases and transfers excess energy from the flue gas to process



fluids flowing through the tubes.

### Needed action

AICs standard line of E-Line economizers is the optimal solution for boiler flue gas heat recovery.

### Horizontal expansion capability

E-Line economisers cover a wide range of boiler sizes and provide real cost and energy savings for commercial and industrial installations. The development of the project has also aided the development of the company's other products such as B-Line Heat Exchangers or B6-Line Heat Exchangers using stainless steel as an integral part of any efficiency improvement programme.

### Outcome

Creating an E-line of heat exchangers have the following features & benefits: Increased system efficiency, real energy and cost savings, converts standard boilers into condensing boilers, increases existing boiler efficiency by up to 20%, unique tube design for optimal thermal performance, easy installation, low maintenance.





## EW-Pellets

### Member company

**Acerinox Europa**

### The Challenge

EW-Pellets, specifically address the challenges related to pellet stove flue gas evacuation. EW-Pellets is designed for applications where traditional flue gas extraction is required. This system is manufactured from high quality stainless steel, ensuring durability, corrosion resistance and compliance with harmonised European standards EN 1856-1 and EN 1856-2.

### Why?

The decision to address this challenge arose from the growing demand for safe and efficient solutions for pellet stove smoke evacuation. With the availability

of EW-Pellets they can offer their customers a full range of options, from standard installations to more specialised applications.



### Needed action

Specific measures were taken to adapt the system to its respective applications in order to solve these challenges and develop the EW-Pellets. This product incorporates features such as "Te pellets" for easy cleaning. This system is made of high quality stainless steel and is certified according to the harmonised European standards EN 1856-1 and EN 1856-2, ensuring compliance with safety and performance standards.

### Action review

*Specific:* To develop and obtain certification according to harmonised European standards EN 1856-1 and EN 1856-2 for modular metal chimney systems (EW-Pellets) made of AISI 316L and AISI 304 stainless steel, respectively, for the extraction of smoke from pellet

stoves.

*Measurable:* The achievement of the Certification according to EN 1856-1 and EN 1856-2 for the EW-Pellets products, following the submission of technical documentation in accordance with the requirements specific tests.

*Achievable:* It has been demonstrated that certification to EN 1856-1 and EN 1856-2 is achievable through the implementation of design and manufacturing processes that comply with the required technical standards and collaboration with accredited testing laboratories.

*Realistic:* Obtaining certification to EN 1856-1 and EN 1856-2 standards has been realistic, as these are recognised and accepted in the European market as indicative of product compliance with safety and performance requirements.



In addition, by choosing stainless steel as the main material has contributed to meeting the strength and durability criteria required by these standards.

*Time-bound:* By pre-established timeframe, with specific milestones set for each stage of the process, from initial research to final certification, the development and achievement of certification to EN 1856-1 and EN 1856-2 for EW-Pellets products has been completed.

## Horizontal Expansion Capability

The approaches and measures taken for the development of these products can be applied in other areas of the company. EW-Pellets provides a solid framework to adapt and apply solutions to different contexts within the company, always ensuring the use of high quality stainless steel and certification to harmonised European standards EN 1856-1 and EN 1856-2 to meet safety and performance standards.

## Outcome

Since the implementation of EW-Pellets, a huge amount of benefits has been observed in terms of safety, customer satisfaction and efficiency. EW-Pellets with the use of high quality stainless steel and certification to European standards, has contributed to increasing customer confidence in the brand and consolidating its position in the pellet stove market.



## Gas Turbine Exhaust System

### Member company

North American Stainless

### The Challenge

Avoid corrosion in materials used in Gas Turbine Exhaust Systems.

### Why?

Due to the gases and temperature generated by the combustion in Gas Turbines, materials employed in manufacturing of the exhaust systems needed to have corrosion resistance in order to lower maintenance costs and ensure long product life.

### Needed action

Based on a study of building materials, NAS stainless steel grade T409 was selected as the best option for its corrosion



resistance.

### Action review

*Specific:* Studies of different materials concluded that NAS grade T409 was superior in corrosion resistance as compared to alternatives such as galvanized steel and it was superior in heat resistance compared to materials such as

aluminum.

#### *Measurable:*

Corrosion resistance of T409 is measurable by specific corrosion resistance testing.

*Achievable:* Initial objectives were achieved, by using T409 in the fabrication, the

exhaust system does not show evidence of corrosion that otherwise would be present with other materials.

*Realistic:* Manufacturing the exhaust system with T409 is realistically possible as NAS can supply the material for this application in an ongoing basis.

*Time-bound:* Manufacturing of the exhaust

system is achieved in a timely manner with ongoing shipments of NAS T409.

### Horizontal expansion capability

The use of NAS T409 can be expanded to other types of exhaust systems that require corrosion resistance at specific temperatures.

### Outcome

Benefits include less maintenance of the product as well as longer product life.





## Honjo River Tsunami Gate

### Member company

**Nippon Steel Stainless Steel Corporation**

### The Challenge

It is expected that a major earthquake along the south coast of Japan is likely to occur in the near future. To prepare for this, Hyogo prefecture has drawn up a plan to construct a new flood gate to protect against tsunamis at the mouth of the Honjo River, located in the southern part of Awaji Island. Although tsunamis do not occur frequently, the damage they cause is enormous, so facilities to counter the effect of a tsunami must be able to operate reliably in times of emergency. Therefore it was necessary to utilize cutting-edge design technology in its construction.

Taking into consideration the

environmental impact and carbon footprint, the material for the facility should not require repainting for maintenance. Accordingly, we proposed duplex stainless steel, which is resistant to salt water. This material has high strength and reduces overall weight. These properties of duplex stainless were successfully evaluated, and as a result it was chosen for the construction of the facility.

### Why?

Since facilities specialized for tsunamis are not in operation during normal times, it is difficult to assign a person to manage them at all times. As a result, the facility may not be properly maintained.

In light of this, we felt it would be of great social benefit to propose the use of stainless steel for the entire structure so

that rusting would not prevent the gate from operating safely and properly during an emergency.

### Needed action

The structure needed to be as simple and lightweight as possible, and it was necessary to select a stainless steel grade that suited this kind of structure. In particular, since the tsunami gate would be installed at the mouth of an estuary, it was necessary to select a grade that would be resistant to salt damage.

In line with this concept, three grades of duplex stainless steel were adopted depending on the application. The gate leaf is made of SUS323L, which has high strength and makes the gate lighter. The front roller uses high-strength yet resource-saving SUS821L1, and the submerged roller tread is made of



seawater-resistant SUS329J4L. These materials made it possible to simplify the structure by using a girder structure. Furthermore, it also allowed the adoption of the cernit gate, which can efficiently transmit water pressure to the gateposts and enable the rollers to be reduced in diameter.





## Action review

*Specific:* The gate leaf is made of a durable, semi-permanent material that can be maintained even in high-saline coastal conditions. A simple and cost-effective girder structure was adopted. And, to ensure reliable operation of the gate leaf, a roller gate was used to minimize friction during opening and closing. The cernit gate system was adopted to minimize the roller diameter and efficiently transmit water pressure.

*Measurable:* High-strength duplex stainless steel could reduce the weight of the gate leaf to 150 tons, about 20% lighter than the 180 tons for a carbon steel gate of equivalent gate leaf area.

### *Achievable:*

1. The use of high-strength duplex stainless steel made it possible to meet the latest earthquake resistance standards without increasing the weight of the gate leaf.
2. The use of highly corrosion-resistant duplex stainless steel eliminates the need for repainting, and reduces future maintenance costs.
3. The use of a cernit roller gate with a girder design made it possible to develop a simple structure that could transfer tsunami loads to the gateposts.

### *Realistic:*

1. The steel grade was selected by analyzing data on corrosion caused by salt water damage.
2. The design was based on the use of duplex stainless steel.
3. Tests were conducted in advance to develop the welding techniques required for the fabrication of the sluice gate.

*Time-bound:* Construction was completed in September 2023 within five years of the start of construction as scheduled.

## Horizontal expansion capability

The technology introduced at the Honjo River Flood Gate can be deployed around the world to help prevent the damage from tsunamis.

## Outcome

With the completion of the Honjo River sluice gate, we believe that all-stainless steel structures can become the standard for tsunami protection facilities throughout Japan. We also felt a sense of unity in working towards the same goal of contributing to Japan's national land resilience with clients, designers, and other project stakeholders.

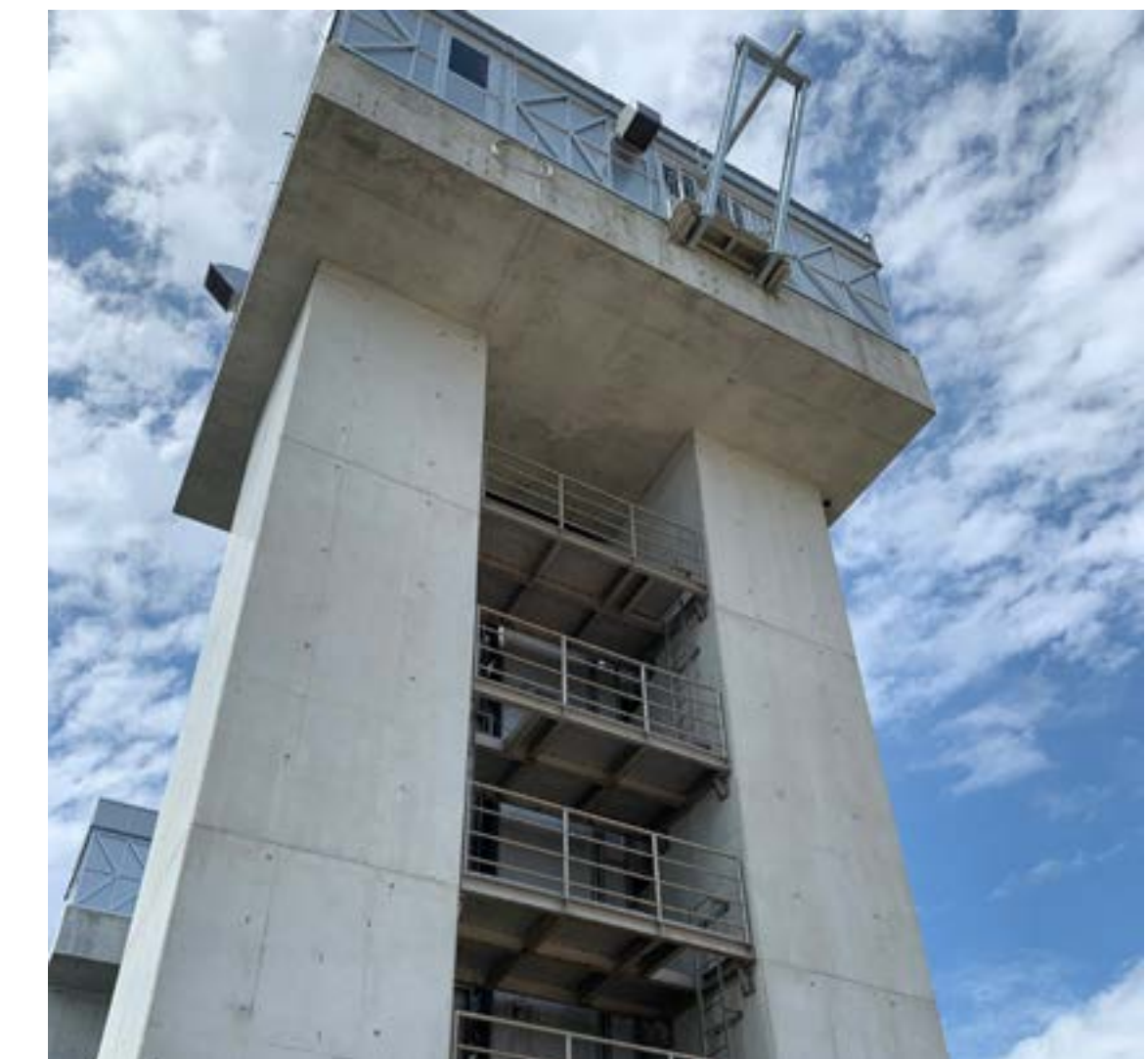



## Twin-biomass

### Member company

**Acerinox Europa**

### The Challenge

Twin-biomass, addresses the challenges related to pellet stove flue gas evacuation. Twin-biomass stands out for its functionality in a sealed pellet stove, where precise airflow control is needed to ensure a safe and efficient environment. This system is manufactured from high quality stainless steel, ensuring durability, corrosion resistance and compliance with harmonised European standards EN 1856-1 and EN 1856-2. The election of this system depends on the specific needs of the installation and the characteristics of the equipment used.

### Why?

The growing demand for safe and efficient solutions for pellet stove smoke evacuation made the decision to address this challenge. With the availability of Twin-biomass, they can offer their customers a full range of options.

### Needed action

To solve these challenges and develop the Twin-biomass products, specific measures were taken to adapt the system to its respective applications. Twin-biomass focuses on completely separating the stove space from the surrounding environment, ensuring safe and efficient operation in airtight stoves. This system is made of high quality stainless steel and is certified according to the harmonised European standards EN 1856-1 and EN 1856-2, ensuring compliance with safety and

performance standards.

### Action review

*Specific:* To obtain and develop the certification according to harmonised European standards EN 1856-1 and EN 1856-2 for modular metal chimney systems (Twin-biomass) made of AISI 316L and AISI 304 stainless steel, respectively, for the extraction of smoke from pellet stoves.

*Measurable:* Certification according to EN 1856-1 and EN 1856-2 has been achieved for the Twin-biomass products, following specific tests and the submission of technical documentation in accordance with the requirements.

*Achievable:* Through the implementation of design and manufacturing processes that comply with the required technical







standards and collaboration with accredited testing laboratories, it has been demonstrated that certification to EN

1856-1 and EN 1856-2 is achievable.

*Realistic:* It is realistic to obtain certification to EN 1856-1 and EN 1856-2 standards, because these certificates are recognised and accepted in the European market as indicative of product compliance with safety and performance requirements. Furthermore, the choice of stainless steel as the main material has contributed to meeting the strength and durability criteria required by these standards.

*Time-bound:* The development and achievement of certification to EN 1856-1 and EN 1856-2 for Twin-biomass products was completed within the project's pre-established timeframe, with specific milestones set for each stage of the process, from initial research to final certification.

## Horizontal expansion capability

The measures and approaches taken for the development of this product can be effectively applied in other areas of the company where similar challenges related to smoke evacuation or ventilation management are faced. Twin-biomass provides a solid framework to adapt and apply these solutions to different contexts within the company, always ensuring the use of high quality stainless steel and certification.

## Outcome

Since the implementation of this product, significant benefits have been observed in terms of safety, efficiency and customer satisfaction. The use of high quality stainless steel and certification to European standards, has contributed to increasing customer confidence in the

brand and consolidating its position in the pellet stove market.





## Round-dot patterned stainless steel plate enables smooth operations with roll box pallet

### Member company

**Nippon Yakin Kogyo Co., Ltd.**

### The Challenge

Checkerboard patterned steel floor plates have been widely adopted in many factories and plants due to their anti-slip properties. However, these plates often require a coat of paint for rust prevention. This coating can peel off during long-term use, exposing steel parts underneath to rust. There's also the concern of flaked-off coat contaminating industrial products, resulting in the need for regular maintenance which requires a lot of time, cost, and effort.

Stainless steel floor plate has been introduced to overcome this issue, since it has excellent corrosion resistance without any additional painting or coating on its

surface.

Despite this, stainless steel floor plate designed with a checkerboard pattern as per ASTM A793 standards, have its drawbacks including challenges in sweeping, poor drainage after washing, loud noise from the rolling of roll box pallets, and the increased force required for transportation. These problems persist even after switching from iron to stainless steel.

Furthermore, stainless steel floor plate is often cold worked to create the pattern shape on its surface. Since the workload of this process is high, the thickness of these plates is limited to a maximum of about 3mm, making the products relatively thin. Consequently, ensuring strength solely through the material is challenging, complicating their application for stairs or stages.

### Why?

There is a demand for stainless steel floor plates that, while retaining their anti-slip property, also offer improved cleanability, better drainage, and easier movement of push carts. Addressing these issues could not only increase their adoption in factories but also help expand business into new markets.

### Needed action

POLKA PLATE is round-dot patterned floor plate, made of Type 304 stainless steel (Fig.1). It offers anti-slip property on par with traditional checkerboard patterned plates. The round-dot convex with a lower height facilitates easier cleaning and better water drainage compared to the checkerboard pattern. Fig. 2 illustrates the results of a cleanability comparison where colored sand was swept off both POLKA

Figure 1: Appearances: Polka Plate



Figure 1: Appearances: round-dot pattern and checkerboard-pattern

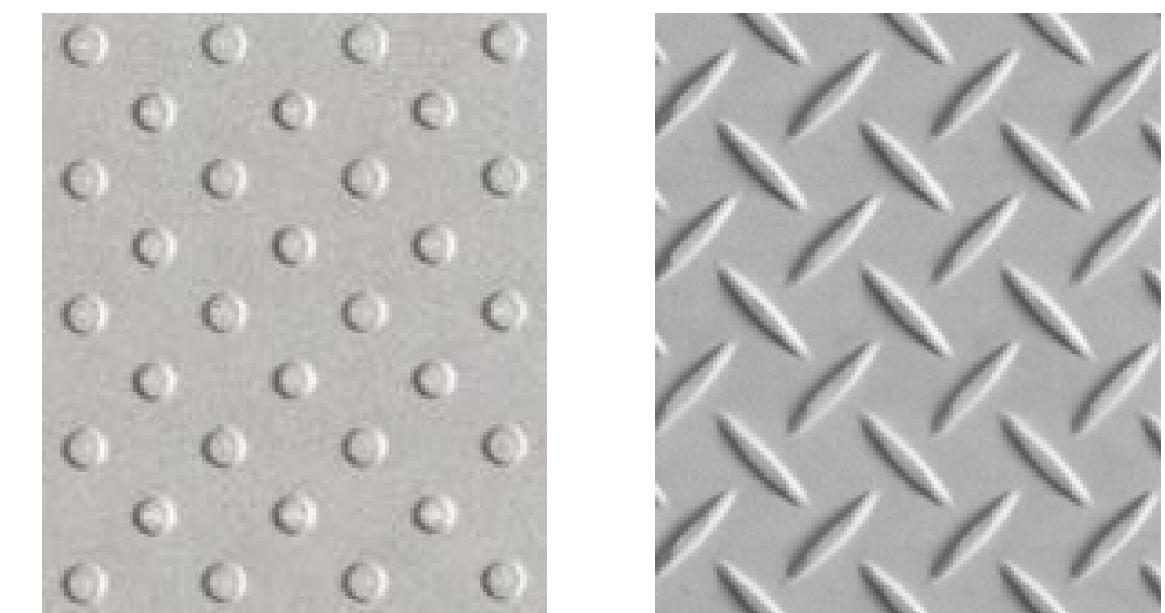
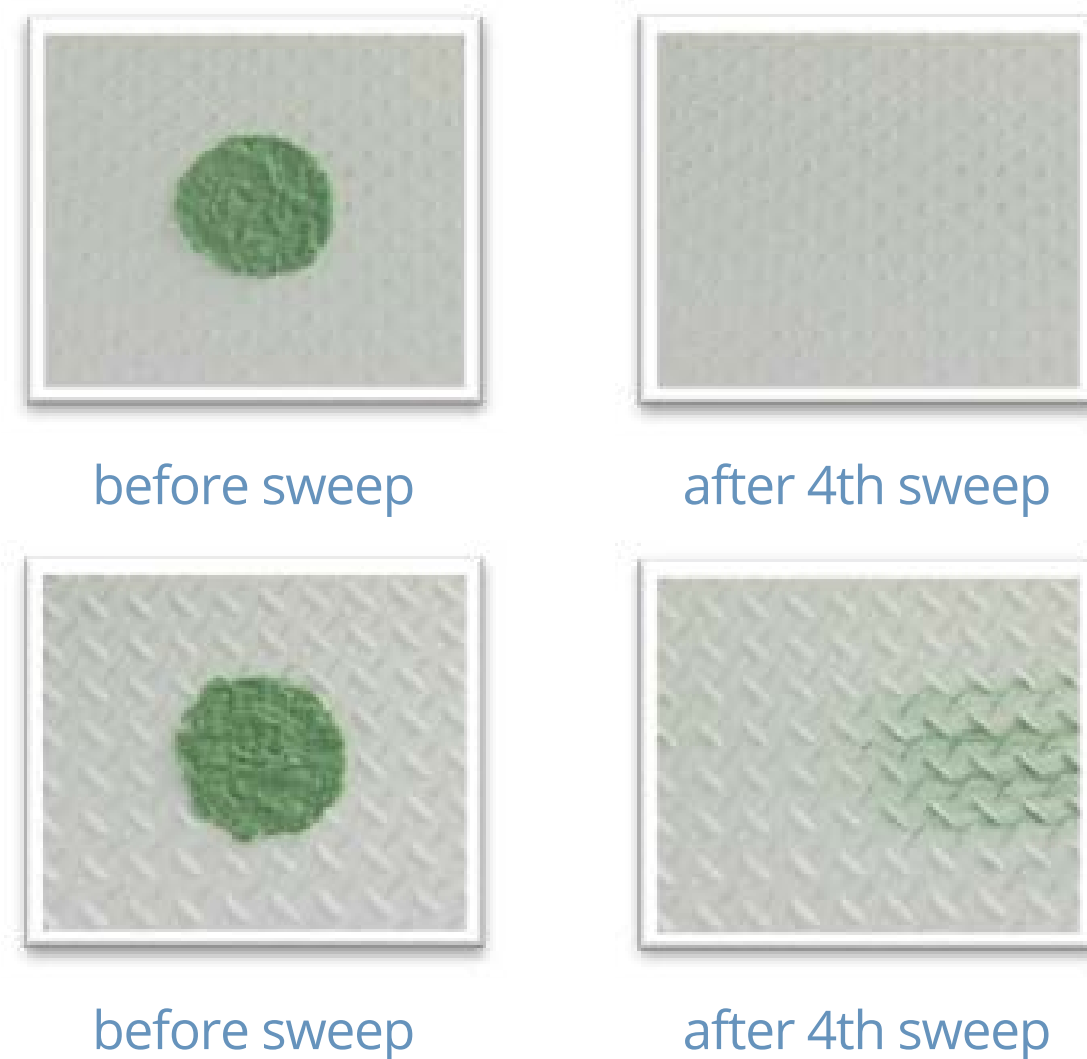

PLATE and checkerboard patterned plates;



Figure 2: The results of the cleanability test



POLKA PLATE became clean after just four sweeps, while residue remained on the checkerboard patterned plates.

Additionally, the followings were measured in an anechoic chamber: the force required to move a roll box pallet over both POLKA PLATE and checkerboard patterned plate,

Figure 3: The results of roll box pallet moving test

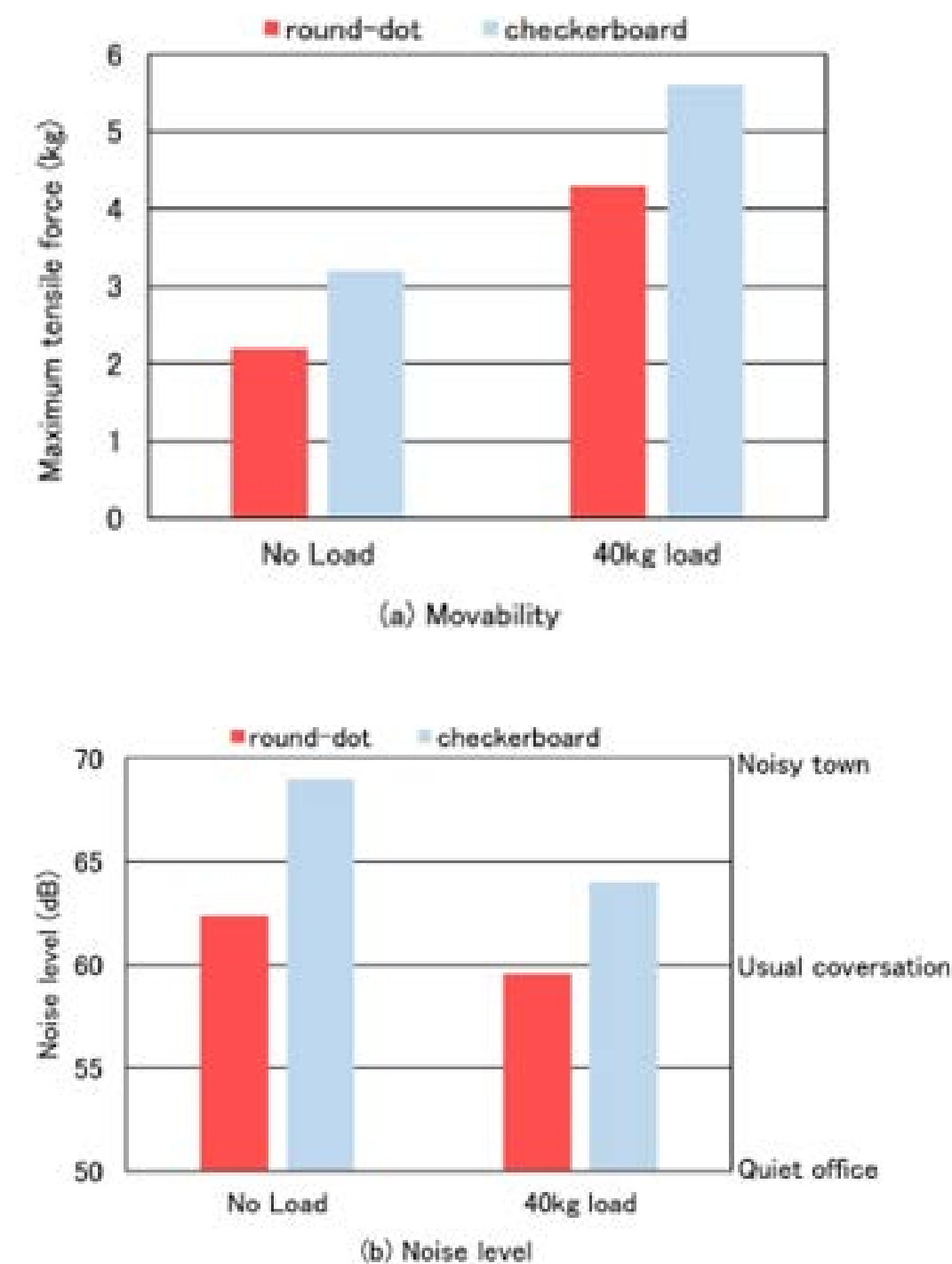

along with the noise level produced during

the movement recorded from a distance of 1 meter. Measurements were taken with the roll box pallet both unloaded and loaded with a 40kg weight, showing that POLKA PLATE required less force to move in both cases. Noise levels generated were also lower for POLKA PLATE, around 60dB, which is comparable to normal conversation levels, regardless of the load.

These findings confirm that POLKA PLATE matches the checkerboard patterned plate in anti-slip property while surpassing it in terms of cleanliness, water drainage, and ease of moving roll box pallets.

Moreover, POLKA PLATE can be produced with a thickness of up to 6mm through hot working process, showing a significant increase over the maximum thickness achievable by cold working. This enables the use of thicker plates for structures like stairs and stages, offering increased

strength and resistance to flexing when walked on.

### Action review

*Specific:* The comparative measurements of cleanability, water drainage, ease of moving roll box pallets, and noise levels during operation highlight POLKA PLATE's advantages over checkerboard patterned plates (Fig.2, Fig.3).

*Achievable:* Notably valued for its cleanability, POLKA PLATE has been adopted for floors in food factories and elsewhere. Its ease of moving roll box pallets and lower noise levels have also led to its use as flooring in the cargo areas of box trucks.

*Realistic:* Already adopted.

*Time-bound:* Already adopted.



## Horizontal expansion capability

POLKA PLATE excels in anti-slip property, cleanability, and water drainage. Its availability of thicker plates for structures like stairs and stages results in stronger constructions that are less prone to flexing. Leveraging these features, POLKA PLATE is widely used in various locations including floors, stages, and stairs in places such as food factories, cosmetic factories, and fine chemical factories. It is also applied on decks and inspection walkways on ships. There is an expectation of continuing

growth in demand within all these sectors and other related industries. It's also anticipated to find broader applications in facilities handling powders and particulates.

In addition to the features above, the ease of moving roll box pallets and the reduction in noise levels have led to its adoption for cargo floors of some manufactures' box truck. It is expected that the demand in this area continues to grow in the future. Applications for floors in commercial elevators, frequently accessed

by roll box pallets and push carts, are also anticipated.

Furthermore, in the healthcare and welfare sectors, its use is expected to extend to floors and ramps in hospitals and care facilities, where wheelchairs and gurneys are used.

Moreover, POLKA PLATE is recognized not only for its exceptional anti-slip property and cleanability but also for providing a soft impression by its appearance.

POLKA PLATE can be cut without hitting

the pattern due to the small size of its round-dots. This makes welding easier compared to checkerboard patterned plates, resulting in an attractive appearance of the final products. Taking advantage of this feature, it is expected to broaden its applications for floors, gutter guards, and stairs in commercial facilities, department stores, boutique, and museum shops, where aesthetic feelings and design qualities are sought after.



# Technology Case Studies





# Development of Water-Soluble Belt Grinding Oil for Coil Grinding lines

**Member company**  
**JFE Steel Corporation**

## The Challenge

In order to produce attractive stainless steel finishes, or to remove surface defects, the surface of stainless steel strips are finished by the coil grinding line or the coil polishing line. The belt grinding oil is used as a lubricant in these lines. Since this belt grinding oil is based on mineral oil, it is flammable, and there is a high risk of fire occurring by the accidents such as strip breakages, various equipment troubles. It is desirable for fire prevention to use non-flammable water-soluble belt grinding oil, but such type of oil is said to be inferior to mineral oil-based oil in terms of grindability and the lifespan of the grinding belt. In this project, we developed and put into practical use the water-soluble belt

grinding oil that has grinding properties equivalent to or better than conventional grinding oils.

## Why?

There have been several fire cases at coil grinding lines from the past. Though there has been the appropriate fire extinguishing equipment, the grinding equipment had been damaged by fire in a few cases, resulting in long-term machine downtime.

## Needed action

In collaboration with Idemitsu Kosan Co., Ltd., we have developed a water-soluble belt grinding oil that has better grinding properties than mineral oil-based belt grinding oils.

## Action review

**Specific:** We conducted grinding tests using actual machines. The quality control methods for the water-soluble belt grinding oil were defined, making it possible to maintain stable grinding performance.

**Measurable:** Compared to mineral oil-based belt grinding oils, water-soluble belt grinding fluids suppress abrasion of the abrasive grains of the grinding belt, and the amount of grinding decreases less over time. Fig 1, 2

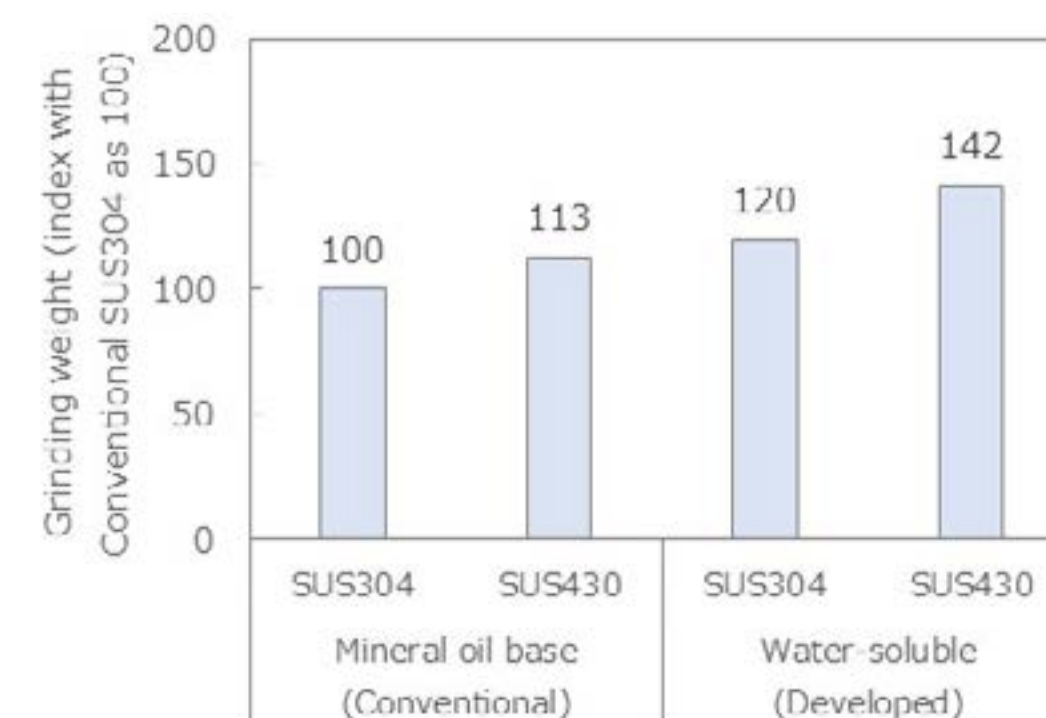

Fig. 1 Relationship between total grinding amount and oil type (Test machine in laboratory)

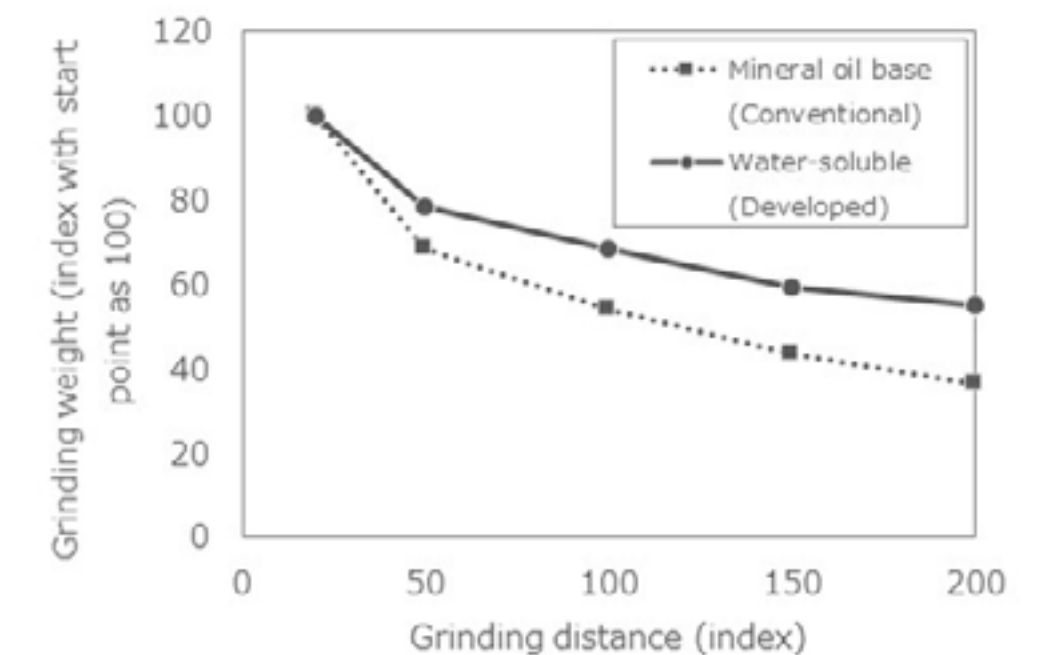

Fig. 2 Relationship between grinding amount and grinding distance (Grinding material : SUS430\*No.1, test machine in laboratory)

**Achievable:** By conducting experiments on actual machines and setting appropriate quality control standards for the water-soluble belt grinding oil, we were able to use the product in actual machines.

**Realistic:** The developed water-soluble belt grinding oil has been installed in all three stainless steel coil grinding lines of JFE Steel Corporation.

**Time-bound:** Development began in



2017. After development and evaluation in the laboratory and evaluation on actual machine, it was first applied at Chiba No. 2 CGR (Coil Grinding Line) in 2021. After that, it was applied to Chiba No.1 CGR in 2022 and Nishinomiya CGR in 2023.

### Horizontal expansion capability

The developed water-soluble belt grinding oil has been installed in all three stainless steel coil grinding lines of JFE Steel Corporation.

### Outcome

By reducing the risk of fire, the regulation of the hazardous material storage facility as stipulated by Japanese domestic

law were abolished, and the costs for undergoing regular statutory inspections were reduced. Disaster prevention monitoring operators are no longer required, reducing the number of operators. In addition, the lower limit of plate thickness was expanded, once it had been limited due to concerns about sparks caused by contact between the belt and roll. As a result, the grinding works

that had previously been outsourced was brought in-house and that led to cost reduction.

### Other comments

Horizontal expansion is underway on the coil polishing line. Scheduled to conduct grinding tests using the actual machine in 2024.



# Austenitic Stainless Steel with High Strength and Cryogenic Toughness for Liquefied Hydrogen Environment

## Member company

**POSCO**

## The Challenge

Hydrogen is one of the main keys to solve the problem of fossil fuels. Thus, it is expected that the demand of hydrogen will be increased globally. Therefore, a large quantity of hydrogen will be transported by shipping between continents and stored in the port. In this hydrogen society, the liquefied hydrogen with high volumetric mass density is more suitable than gaseous hydrogen to transport or store. Especially, to store the liquefied hydrogen, tank material must be withstood at cryogenic conditions (-253°C) and had a good resistance of hydrogen embrittlement. It is well known that the stable austenite has better hydrogen embrittlement resistance than metastable austenite. Thus, austenite stability of steel

should be considered to design the alloy. To use at cryogenic conditions, a new alloy was designed by the addition of nitrogen since it is the best alloying element which can be increased both austenite stability and strength of stainless steel. However, the addition of nitrogen can be caused the decrease of cryogenic toughness because of decreasing the stacking fault energy.

Therefore, we tried to optimise the composition of newly developed the high nitrogen contained austenitic stainless steel, which has high strength and resistance of hydrogen embrittlement as well as good cryogenic toughness. In addition, a suitable weld material for this alloy grade that applies to liquefied hydrogen storage tank should have been developed.

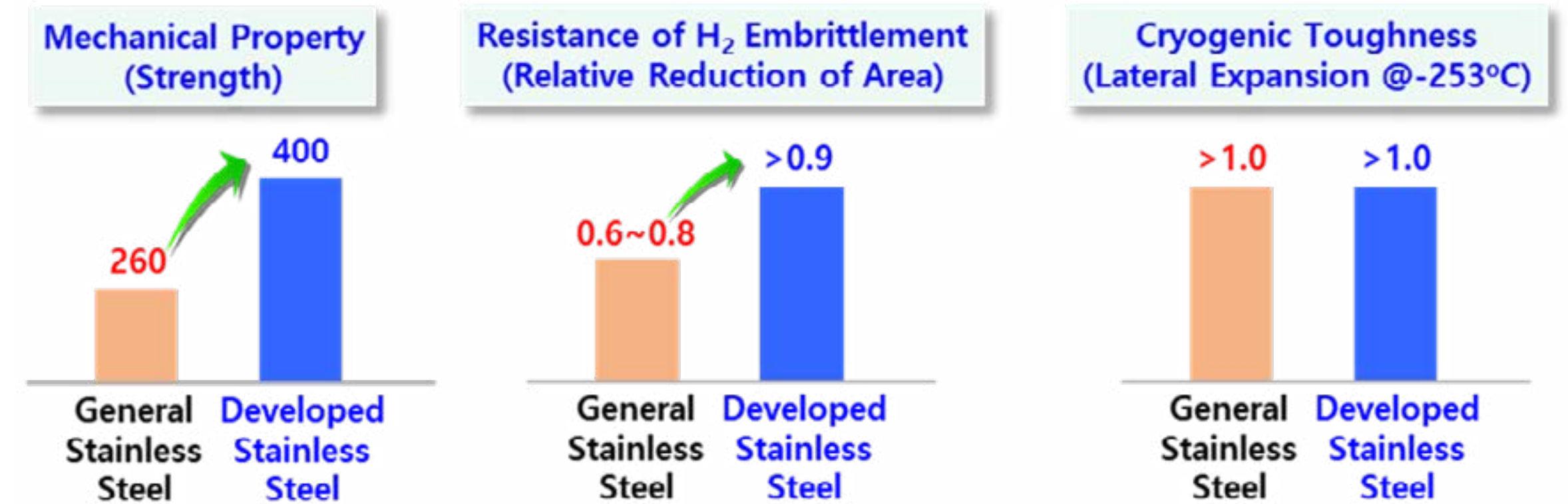

Mechanical property, Resistance of H<sub>2</sub> embrittlement, and Cryogenic Toughness of general and developed stainless steels

## Why?

The development of high strength stainless steel with good cryogenic toughness and resistance of hydrogen embrittlement as well as weld material is our role, and finally, it comes to increase the efficiency of the liquefied hydrogen transportation and storage. Therethrough, it can bring forward to establish infrastructure for hydrogen society.

## Needed action

Competitive alloy design focused on elements (Nitrogen, Manganese, Nickel et al.) which affect the strength and austenite stability, was carried out by considering the increment of stacking fault energy. In addition, optimization of manufacturing process which were hot-rolling, pickling and heat treatment as well as cold manufacturing conditions, was performed.



## Action review

**Specific:** Hydrogen is one of very important energy sources. So, high strength stainless steel with good cryogenic toughness and resistance of hydrogen embrittlement as well as weld material has been developed to increase the efficiency of the liquefied hydrogen transportation and storage. The development and evaluation of new stainless steel were performed in the points of view from strength, cryogenic toughness, and hydrogen embrittlement characteristics.

**Measurable:** New stainless steel showed a high strength and good cryogenic toughness. The former was above 310 MPa (yield strength) and the latter was above 100 J at -253°C. In addition, it had an excellent resistance of hydrogen embrittlement that RRA (relative reduction of area) was above 0.9.

**Achievable:** New stainless steel for

liquefied hydrogen has higher strength, cryogenic toughness, and resistance of hydrogen embrittlement than those of general austenitic stainless steel such as 304L and 316L.

**Realistic:** Optimization of manufacturing process of new stainless steel was performed. Therefore, it can be used whenever liquefied storage tank is needed.

**Time-bound:** The development of new stainless steel has been taken for 2 years to achieve the goals.

## Horizontal expansion capability

New stainless steel has an excellent resistance of hydrogen embrittlement under more higher pressures of gaseous hydrogen state, which is not experienced with the usage of liquefied hydrogen tank. Generally, the liquefied hydrogen tank is used under the maximum of 2MPa. Therefore, it is expected to be used as a

material for high pressure utility and pipe in hydrogen refuelling station in the future.

## Outcome

The thickness of liquefied hydrogen storage tank wall can be reduced due to its high strength. Moreover, the life span of liquefied hydrogen storage tank will be increased because of high cryogenic

toughness and excellent resistance of hydrogen embrittlement. In addition, suitable weld material for high nitrogen stainless steel has been developed.

## Other comments

New stainless steel is the most optimum material for liquefied hydrogen atmosphere among the general stainless steels due to its excellent performances which are high strength, cryogenic toughness, and resistance of hydrogen embrittlement. In detail, alloy design for new stainless steel that the controls alloy elements (Nitrogen, Manganese, Nickel et al.) has been performed. Therethrough, new stainless steel has high strength and excellent resistance of hydrogen embrittlement. Moreover, it has enough cryogenic toughness at liquefied hydrogen environment due to high stacking fault energy, even though it has a high nitrogen content.

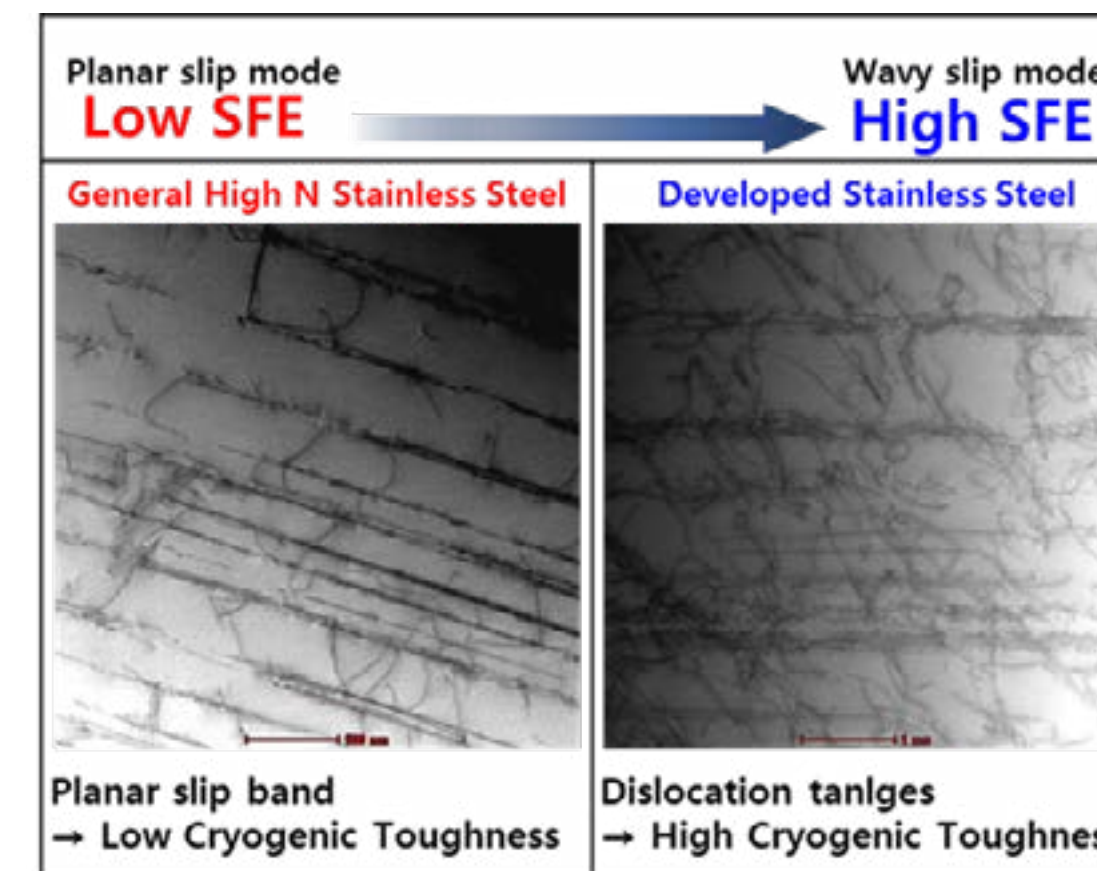

TEM image of general high N stainless steel and developed stainless steel



## High Conductive Ferritic Stainless Steel for Solid Oxide Fuel Cell Separator

### Member company

POSCO

### The Challenge

Recently, the requirement of materials for SOFC\*/SOEC\*\* to use the hydrogen fuel cell power plant and the hydrogen production by electrolysis is increasing with the growth of the eco-friendly hydrogen market.

\*SOFC: Solid Oxide Fuel Cell, \*\*SOEC: Solid Oxide Electrolyzer Cell

**Separator plate** which is one of the main components in the planar type of solid oxide fuel cell facility, is located in between each individual cell. It is physically separated but electrically connected with the cells. Until now, a stainless steel added rare earth metal(REM) has been widely used since it is well known to have

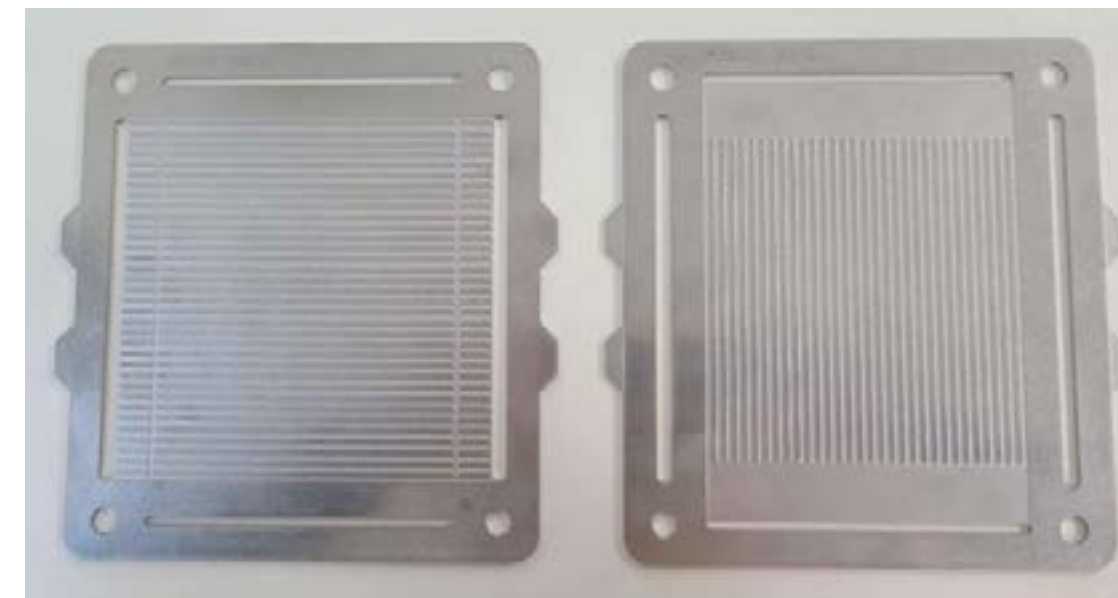

1KW SOFC stack with 460FC separator plates

an excellent conductivity and stability of the surface oxide layer at high operating temperatures.

However, its material cost is very high since it has to be fabricated by vacuum melting process due to the difficulties of adding REM such as La, Zr. Therefore, the

development of cost saving material that meets the requirements of separator plate is one of the most important issues for the commercialization of SOFC and SOEC.

In this development, a new cost effective ferritic stainless steel for separator plate in SOFC has been developed and fabricated by using the conventional continuous casting and rolling process without REM addition. In addition, we developed the technic to form an oxide layer with superior conductivity at high temperatures by controlling the Cr/Mn ratio and adding Nb and Mo.

### Why?

High conductive spinel type oxide,  $(\text{Mn}, \text{Cr})_3\text{O}_4$ , at high operating temperature is obtained by controlling the ratio of Cr and Mn. In addition, we found the addition of Nb and Mo which is formed the Laves

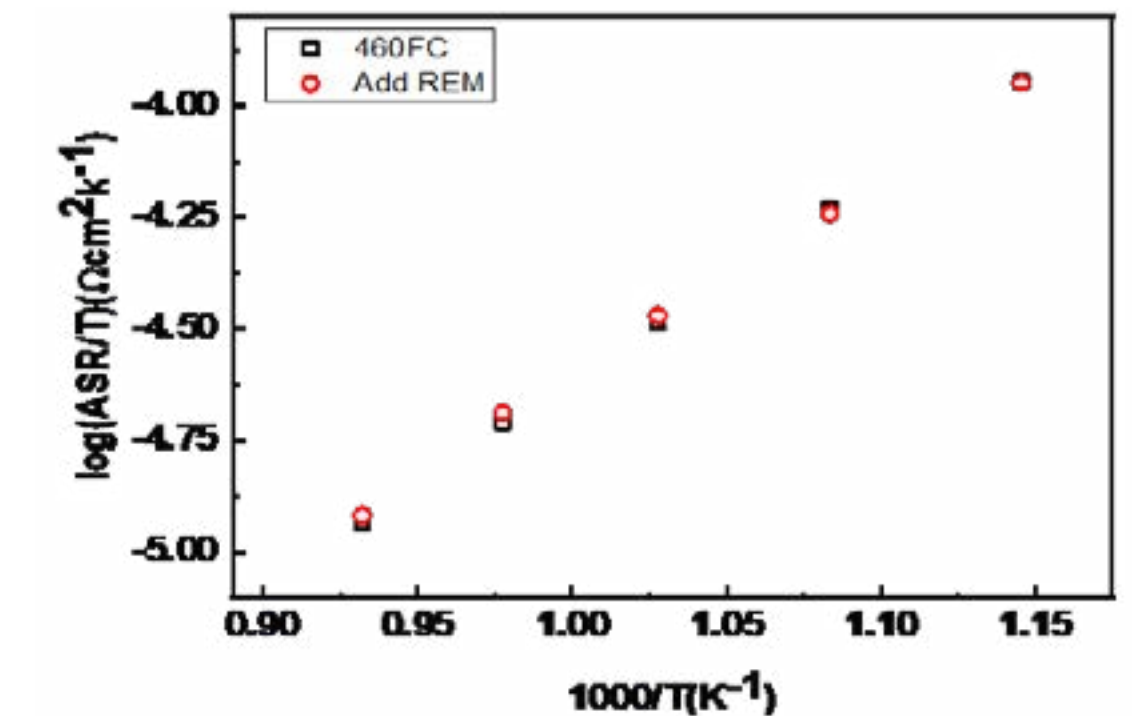

Temperature dependence of ASR after oxidation at 800°C for 500hrs in air

phase,  $\text{Nb}_2\text{Si}$ , is suppressed the formation of Si-oxide film. Si-oxide is known to deteriorating the conductivity because of its insulating property. Moreover, the Laves phase plays an important role to improve the adhesion and soundness of the interface between the matrix and the formed conductive oxide layer. Therefore, we can make it by using conventional continuous casting without adding the element of REM such as La, Zr. .



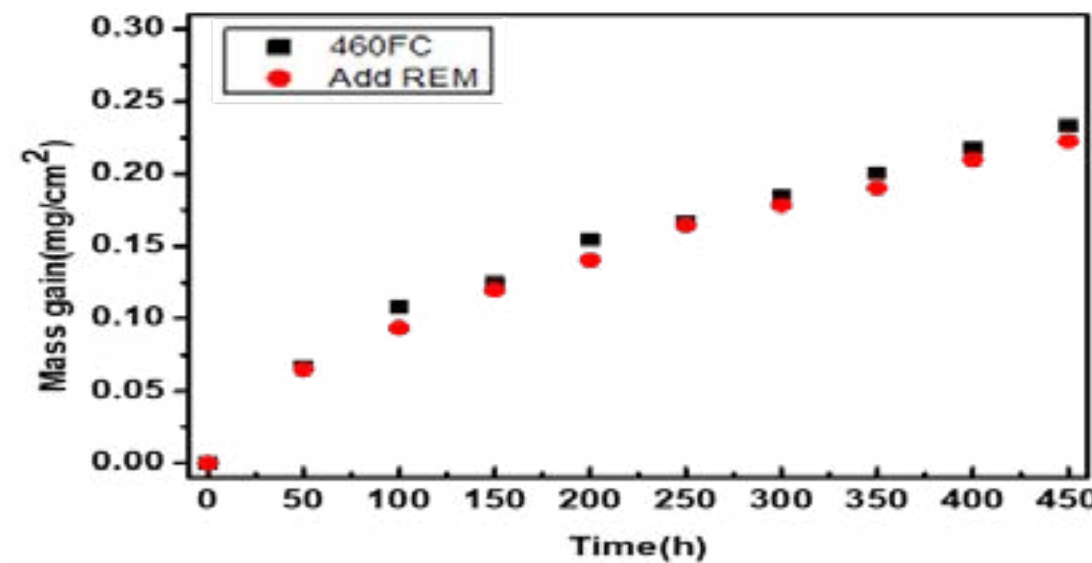

Mass gain of the sample at 800°C in air atmosphere

## Needed action

To provide the high oxidation resistance and conductivity surface properties at high temperatures (~800°C).

1. Optimize the ratio of Cr and Mn contents to form a highly conductive spinel-structured,  $(\text{Mn}, \text{Cr})_3\text{O}_4$  layer on the surface at operating temperature.
2. Optimize the contents of Nb and Mo to improve the oxidation resistance and strength even when it is exposed at

high temperatures for a long time.

## Action review

**Specific:** The highly conductive 460FC can be applied as a solid oxide fuel cell separator plate.

**Measurable:** High temperature ASR (Area Specific Resistance,  $\text{m}\Omega\text{cm}^2$ ), High temperature strength (MPa), High temperature Mass gain ( $\text{mg}/\text{cm}^2$ ).

**Achievable:** 460FC without adding REM is possible to manufacture via conventional continuous casting process. Thus, its manufacturing cost can be saved.

It is also improved the surface conductivity and oxidation resistance at high temperatures by optimizing Cr/Mn ratio and contents of Nb, Mo.

**Realistic:** The high temperature surface conductivity and oxidation resistance of

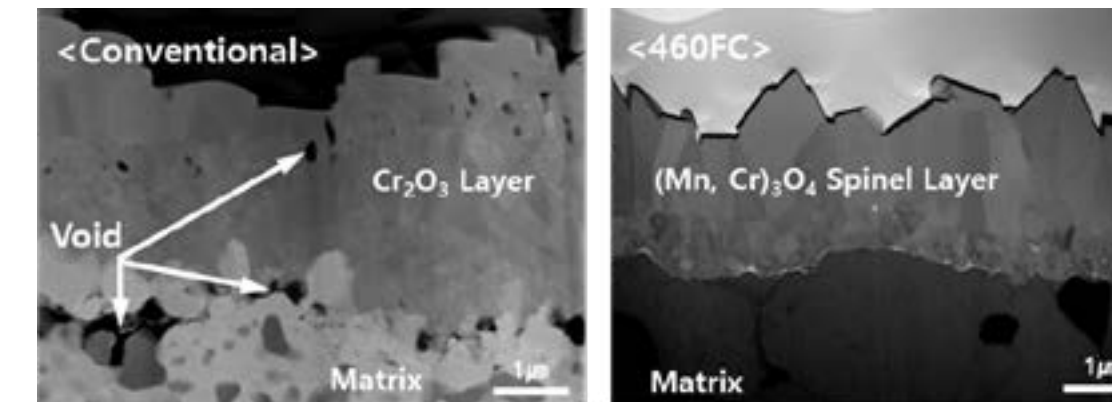

Oxide scale of conventional STS and 460FC after oxidation at 800° for 500hrs in air

460FC were similar with those of REM-added steel.

**Time-bound:** From 2021 to 2024, POSCO succeeded in developing materials for solid oxide fuel cell separators that meet the requirements of global energy development companies.

## Horizontal expansion capability

It can also be applied as a SOEC (Solid Oxide Electrolyzer Cell) separator to produce green hydrogen.

## Outcome

A new ferritic stainless steel, 460FC, without containing rare earth metal which can be contributed to the cost saving of SOFC separator plate, was successfully developed, and fabricated using conventional production facilities. The thermally grown oxide scale formed after isothermal oxidation at 800°C, followed the parabolic growth kinetics and is mainly consisted of outer  $(\text{Mn}, \text{Cr})_3\text{O}_4$  spinel layer.

POSCO plans to apply the high conductivity 460FC stainless steel to SOFC separator plate and will be expected to contribute the popularization of eco-friendly SOFC/SOEC business by saving the manufacturing cost.



## Automatic Surface defects inspection for angle packaging line

### Member company

**Roldan S.A.**

### The Challenge

Automatic surface defects inspection for angle packaging line.

### Why?

Automatic inspection reduces human errors, so the final quality does not depend on human decisions. There are no stops in

the line, so the process speed increases.

### Needed action

Automate the surface inspection process using artificial vision technology.

### Action review

*Specific:* The steps of the project were: Problem description, project definition, specifications, system requirements and technology to be used.

*Measurable:* Defects detections error can be measured and production speed

*Achievable:* Project specifications were 70% achieved. The % completion is based on the type of defects that the system is able to detect.

*Realistic:* All actions were realistic and achieved.

*Time-bound:* Project go live was in time, but still today the system is being adjusted to achieve the objectives in terms of defect

detection %.

### Horizontal expansion capability

Yes, it can, since it is based on generic artificial vision models that can be adapted to other different use cases, materials, etc.

### Outcome

Human costs were reduced by 30% and production speed in the packaging line was increased 25%.



# Safety Case Studies





# SP2 Work Roll Jog from Polisher Control Station

## Member company

Columbus Stainless

## The Challenge

The high levels of noise in the area caused ineffective communication between the operator at the bottom polisher and the process controller. They were required to coordinate their actions to ensure a safe and efficient process. Unfortunately, there was an incident in which the operator at the polisher requested a stop, but the process controller did not hear and kept jogging.

## Why?

The Solution was to enhance safety by addressing key risk factors, such as limited visibility, communication issues, and lack of control over roll operation.

The implementation of the operator control switch and other control measures significantly reduced the likelihood and severity of potential incidents, thereby improving the overall safety of the work environment.

## Needed action

Installed a panel with a jog control switch at the bottom of the polisher area.

## Action review

*Specific:* Installed a jog control switch panel at the bottom of the polisher area via ECR.

*Measurable:*

Risk Assessment - Current Practice:				
Hazard	Probability	Severity	Risk Level	Control Measures
Lack of direct line of sight	B	2	High	Communication protocols, use of signals, supervision
Inadequate communication	C	2	High	No effective control measure in place
Lack of control over roll operation	C	2	High	Supervision, standard operating procedures, safety protocols
Crushing and Pinching Hazards	B	2	High	Safety guards, proper training
Risk Assessment - After Proposed Solution:				
Hazard	Probability	Severity	Risk Level	Control Measures
Lack of direct line of sight	E	5	Low	Direct line of site no longer required as the operator cleaning the rolls is also operating the rolls
Inadequate communication	E	5	Low	Communication no longer required
Lack of control over roll operation	E	5	Low	Operator control switch, training on roll operation
Crushing and Pinching Hazards	B	3	Medium	Rolls jogged in open position



Area below SP2 polisher rolls



This project has a final score of 89%. The cost of implementation is estimated at approximately R4 500.

*Achievable:* Key risk factors that needed improvement were limited visibility, communication issues, and a lack of control over roll operations. These issues were addressed by installing the jog switch.

*Realistic:* By implementing operator control measures, such as the control switch, the potential for incidents can be

significantly reduced in both likelihood and severity. This results in a safer work environment overall.



*Time-bound:* The project was executed successfully and promptly, within a month of its initiation.

## Horizontal expansion capability

Yes

## Outcome

Overall improvement on the following variables:

1. Property Damage - incidents where equipment/property is damaged.
2. First Aid Incidents - incidents where an employee receives on-site medical treatment or reports an incident but receives no medical treatment.
3. Recordable Injuries - injuries where an employee receives medical treatment but not Lost Time Injury.
4. Lost Time Injuries - injuries that prevent an employee from working on the next scheduled workday.
5. Environmental Incidents - incidents reported to governing agencies.

## Other comments

The approximate cost of implementing this project was only R4 500



# Global Machinery Safety Roadmap

## Member company

Aperam

## The Challenge

Machinery Safety remains a hot topic within the steel industry, our machinery is considered one of the heaviest in the world. If we see the results within worldstainless, this is still a TOP 5 safety priority (2022). The challenge within Aperam was to translate it into a multi year action plan (2022-20XX). This plan consists of tree mayor topics:

1. Increase the (general) knowledge about Machinery Safety
2. Independent check of the performed modifications and support during new projects
3. Create a network internally Aperam

with support of global (internal/ external) experts

## Why?

In our yearly H&S analysis, machinery safety incidents (+ near misses included) is still in our top 5 of most risky hazards, the interaction between humans and machines.

## Needed action

First step was to create a multi year action plan, this plan consists of the following tree mayor topics:

1. Increase the (general) knowledge about Machinery Safety
2. Indepenent check of the performed modifications and support during new projects

3. Create a network internally Aperam with support of global experts

The first topic consists of the following:

- a) Select and train an Aperam employee to be (partly) dedicated to machinery safety
- b) Train managers in the (legal) part of machinery safety, this is includes the responsibilities
- c) Train the H&S managers and the technical employees in the existing C-standards (e.g. C-standard 17449 – Finishing machines)
- d) Create an Aperam Global Machinery





5 - Create Aperam Machinery Safety Standard

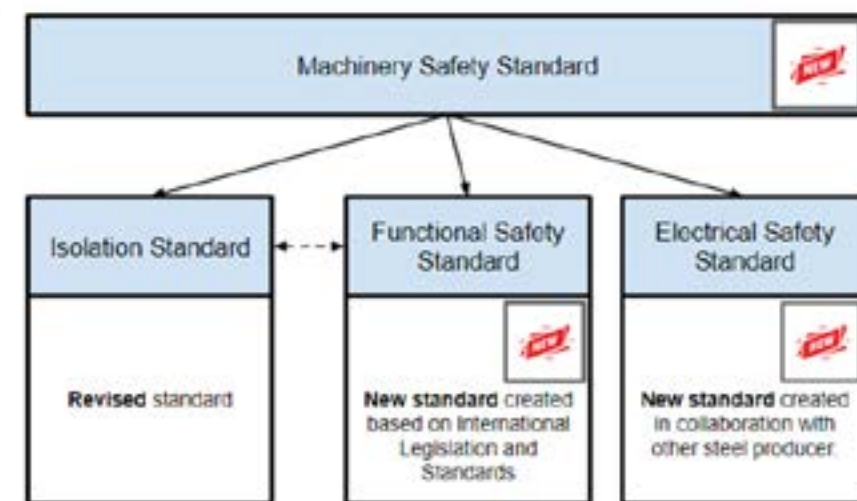

Safety Standard, this standard includes legislation, and the international standards

The second topic consists of the following:

- The internal machinery safety expert gives guidance during the purchase and aftercare of projects and this in line with the legislation
- Create Aperam standards per machine

type as guidance

- Check of the executed modifications/projects on the shop floor

The third topic consists of the following:

- Create an internal Aperam network between the sites experts
- Bench with external experts (+ create training content)

### Action review

**Specific:** This action plan is specifically created to improve **Machinery Safety** within Aperam.

**Measurable:**

- Machinery Safety stays an important risk in the steel industry, analysis of worldstainless and worldsteel shows

this

- Internal follow-up of reported Alerts show us that within Aperam this also has a high priority
- The before and after of the projects has shown a decrease of reported alerts

**Achievable:** The result of the project can be seen in the decrease in the number of alerts reported and the increase in knowledge at all levels of the organisation.

**Realistic:** All actions are discussed in group and considered realistic, CAPEX has been aligned with the project.

**Time-bound:**

- The project has a clear starting point, the end of the project can be considered done when the knowledge

has been at a higher level, and the Alerts are still decreasing over time.

- We must also be aware that standards and legislation are continuously improving/changing.

### Horizontal expansion capability

- The actions/roadmap can inspire others to increase and improve Machinery Safety on site
- Can be used to create a « Sense of Urgency »

### Outcome

- Reported incidents reduced by 40%
- Increase of internal knowledge
- Improved resources to work on Machinery Safety



## Grinding Wheel Tilting

### Member company

Columbus Stainless

### The Challenge

We receive grinding wheels from supplier stacked horizontally on top of each other, and we need to unpack and roll them from the delivery area to pack them in their demarcated vertical stands next to the roll grinding machines. Also when building the steel hubs onto grinding wheels, we must turn the assembly from a vertical position into a horizontal position by lifting them. We have two types of grinding wheels, the 125mm wide, 915mm in diameter which weigh 165 kg, and the 100mm wide, 915mm in diameter which weighs 115 kg. When the steel hubs are built onto the grinding wheel the assembly can easily weigh 200kg.

### Why?

During the process of unpacking and transportation of the grinding wheels from the delivery area to the stands next to the grinders, more than one person must be involved in lifting and converting the grinding wheels from a horizontal to a vertical position, thereafter roll it. This pose serious safety issues which are immediate and some may be observed at a later stage. Among others, the following is the list of safety issues that may occur:

- Injuries (Back injuries, including hands, legs and foot injuries)
- Grinding wheel damage.
- Wheel explosion in the machine in case it cracks during the process of unpacking. This will result in a serious damage to property (Machine) and pose threats to the life of the operator



- that will be on the machine at the time.
  - Inefficient use of resources wherein more than one person is needed just to unpack the grinding wheels.
  - High probability of tripping and falling while pushing/rolling the grinding wheel from the delivery area to the machines, which may result in serious injuries and damage of the wheel and possible damage to property
- Grinding wheels are fragile products therefore they necessitate the operators to hold them with care when they unstack

and turning them from a horizontal to a vertical position, which means the whole weight of the wheel will lie on their bodies while turning them to a vertical position

and bend to put them slowly on the floor. Some of these wheels come stacked in six or more. See photos to show the manual way of unpacking.

*Risk- Back, hand/finger injuries and wheel damage*

Again during the process of building new grinding wheels, more than one person is needed to lift and convert the grinding wheel from a vertical position into a horizontal position and align, slowly lower





and put it into the hub. This process poses serious back injuries and hand/finger injuries, because operators must bend and use their bodies to lift the wheel that weighs up to 165 kg when putting it into the hub, while their hands are holding the wheel from the bottom. See photos below showing the process of building the grinding wheel.

vertical converter lifting equipment. The orbital joint wheel lift and tilter (rig) will be used to unstack the horizontally packed grinding wheels, convert them to a vertical position and transport them to their vertical stands next to the grinders. The rig will also be used when building the grinding wheels, whereby it will be used to turn the wheels from a vertical position to a horizontal position and fit the wheel into the hub. Having suitable lifting equipment for this purpose will prevent a whole

## Needed action

### Proposed solution

Since these grinding wheels are fragile products, we have a specially designed horizontal to

number of injuries and ensure efficient use of resources.

## Action review

*Specific:* Design had to have the following functionality

1. Should be possible to be operated by one person and a crane only.
2. Should be able to accommodate two grinding wheel thicknesses (100mm and 125mm wide)
3. Should be able to convert from horizontal to vertical position as a one handed operation with little to no force needed.
4. Should be able to handle bare wheel and wheel and hub assemblies.
5. No expensive motors and gearboxes or controls to be used

6. Should be very safe and not damage or drop expensive grinding wheels
7. Should be easy to manufacture and maintain locally.
8. Should be manufactured quickly to make use of the limited number of lower cost wheels that are wider and heavier than the normal 100mm wide wheels

### Measurable:

1. Internal limits of weight that may be lifted safely without a crane is 25kg. So to comply with that one would need 8 people to lift a built wheel assembly which is firstly impractical and secondly there are not that many people on shift.



- Although no back injuries have been reported for this job it is not impossible at any time.

**Achievable:** The orbital wheel lifter has been built and can be operated by one person, however using one crane driver and one person to operate the rig is faster and safer.

**Time-bound:** The orbital joint wheel lift and titler concept was given to a local engineering shop who had to do a detailed design drawing, manufacture and build it and have it load tested within 3 months. Some initial balance and alignment issues were sorted out in 3 weeks after the rig was tested on site which made the handling and safety even better.

## Outcome

Having suitable lifting equipment will afford us a chance to get rid of an old production way of working from the floor in our processes during the stripping and building of the grinding wheels. Previously the wheel is removed from the machine by a Jip crane and placed on the floor, it will then be stripped and built there.

With the process improvement, we will design a good height working table that can fit two grinding wheels which are placed horizontally, because we have two types of grinding wheels which means we are using two types of hubs. The hubs will stay on the table at all times to save time of travelling and the handling of a heavy hub with no handles from the demarcated stand to the working area.

In this case the grinding wheel will be

removed from the machine and be placed on the working table by a Jip crane, so that it will then be stripped. We will use the newly designed rig to remove the scrapped grinding wheel, also use the rig to grab the vertically packed grinding wheel, turn it into a horizontal position to be able to fit it into the hub on the working table so that the operator can easily build it. This process improvement ensures efficient use of resources (personnel), prevents immediate and later injuries that may occur when handling a wheel, prevents back injuries during the hand lifting of the grinding wheel, prevents tasks handovers caused by unwillingness due

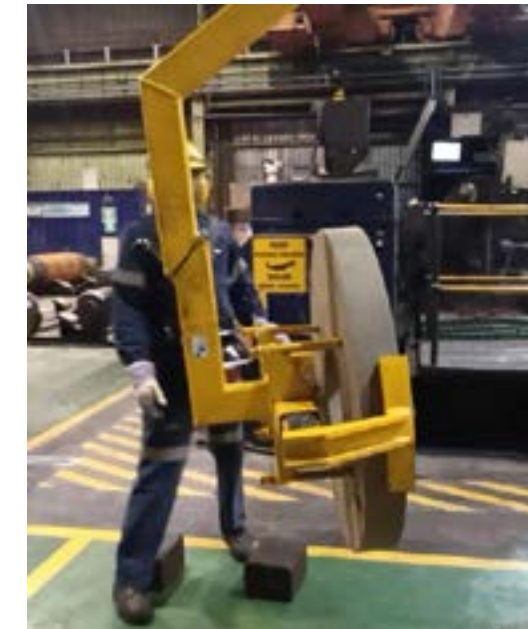

ergonomic issues, and it speed up the process of building the wheel so that the operator will focus on his roll grinding task.

## Other comments

The pictures on this page of the orbital joint lifter picking up a grinding wheel from horizontal position and then converting it to the vertical position. One handed operation by single operator on a 115kg wheel.



## Real time Hot metal driver monitoring

### Member company

Columbus Stainless

### The Challenge

A method to warn Kress operators of unsafe behaviour/conditions in real time while driving. To correct unsafe behaviour and reduce the likelihood of a catastrophic incident from happening.

### Why?

Kress vehicles are heavy duty vehicles that are used to transport hot metal from the Steel Plant to the tipping station. A driver that is fatigued or gets distracted from paying attention to the road is a serious safety risk given the payload they are transporting.

### Needed action

Installed real time cameras looking forward to the road and backwards towards the driver in the cabin. Cameras use AI technology to detect and warn the driver via a voice prompt should an unsafe condition develop or behaviour be performed by the driver. This includes driver fatigue warnings, not looking forward when driving and behaviour that can distract the drivers attention like unauthorised cell phone usage or smoking in the cabin. All alerts (video) are captured for future use to correct behaviour or substandard conditions with detailed evidence.

### Action review

*Specific:* Cameras were installed on all Kress vehicles.

*Measurable:* Training was provided to employees who are responsible for the system. Alerts are investigated and acted upon when required.

*Achievable:* Objectives were achieved. Alerts of unsafe acts or conditions were actioned and addressed.

*Realistic:* Objective was to receive real time alerts of unsafe conditions while transporting liquid slag. This was achieved.

*Time-bound:* Cameras were installed in October 2023 and are in use.

### Horizontal expansion capability

Other companies can replicate the system.

### Outcome

Provide real time alerts of unsafe driver behaviour or conditions like driver fatigue.



### Other comments

Transporting liquid slag on site at Columbus Stainless is now safer due alerts (warning voice prompts) received by the driver in real time which enable the driver to act before it results in an incident.



## Crane Hook Safety Latch

### Member company

Columbus Stainless

### The Challenge

Crane hooks have latches that cause Nip Points whilst attaching a Lifting Rig.

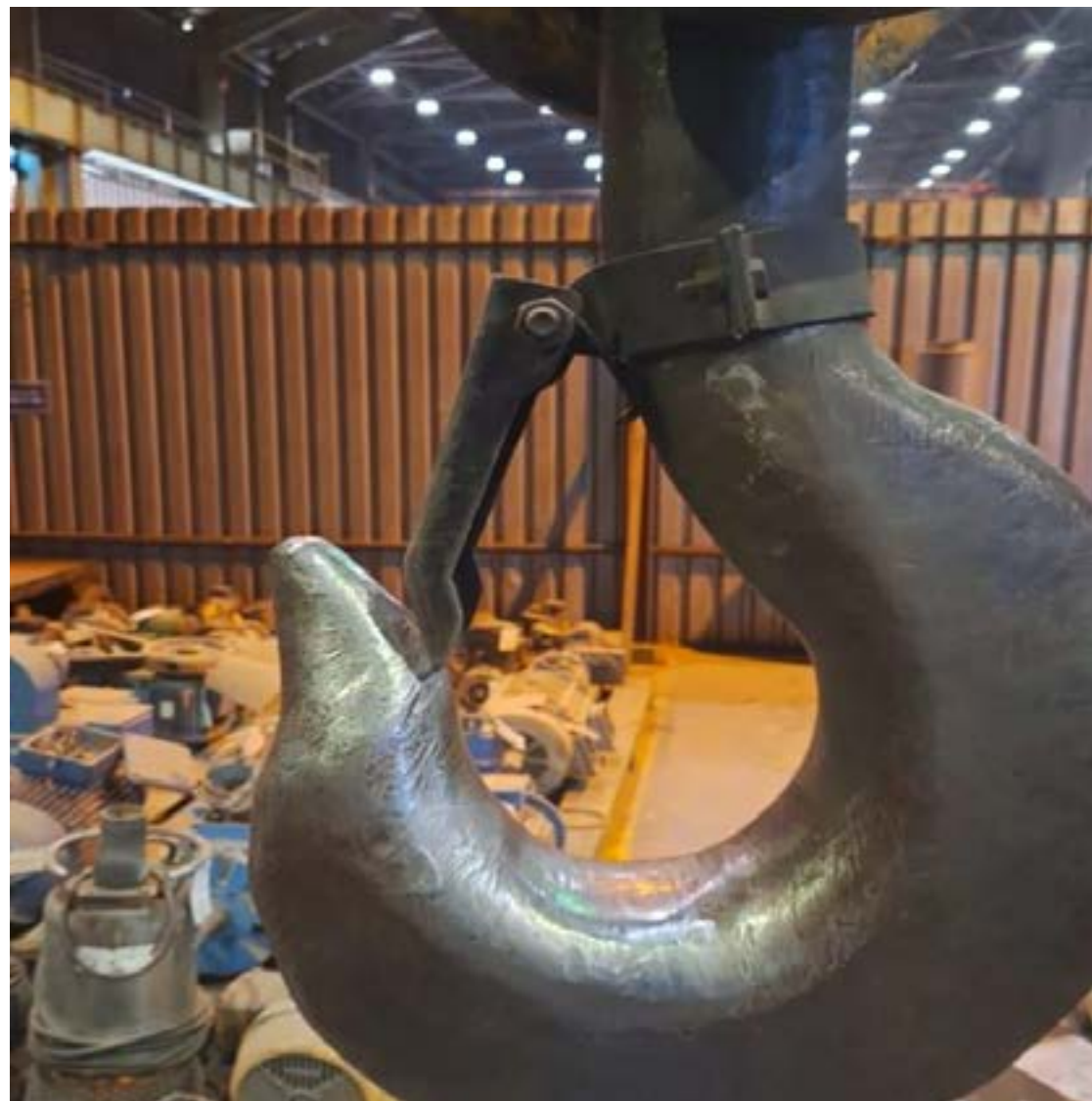

### Why?

Columbus had a finger injury where the latch pinched an employee's finger.

### Needed action

The latch was re-designed to allow the operator to open the latch by standing away from the "load path". The opening of the latch from behind the hook prevents the hand from nearing a nip point while the load is being attached to the hook.



### Action review

**Specific:** A crane latch was designed with an extension towards the back that allows the operator to open the latch while standing away from the load and the operator's hands is away from the nip points caused between the hook, latch and load.

**Measurable:** The latch design was agreed upon in December 2023, manufactured and the first latches were installed at the end of January 2024.

**Achievable:** The objective was to enable

the operator to stand away from the load and not have his hand near the Nip Points i.e. away from the 3 points of danger where the Hook, Latch and Load is engaged.

**Realistic:** The main objective was to address the risk of the operator working in close proximity of the load's nip point and the load path. This has been achieved.

**Time-bound:** Trial installations were completed at the end of January 2024. A site risk assessment was completed with a PJO and the decision was to roll out to all cranes. Due date 30 June 2024.





### Horizontal expansion capability

Yes, this device can be installed on all Cranes with latches on their hooks.

### Outcome

The Operator is taking a safe position whilst attaching the load and his hands are away from all of the identified Nip Points.

### Other comments

The Operator is taking a safe position whilst attaching the load and his hands are away from all of the identified Nip Points.





## Jig for changing press roll at ZM

### Member company

Bahru Stainless

### The Challenge

Rolls changed at the ZM machine have a high risk of falling during disassembly and transfer out of the machine area due to the following conditions: slippage, oiliness, and restricted space for the rolls to be changed. There may be accidents that cause severe injuries or property damage when the rolls fall from the hand. This could lead to costly legal actions, decreased productivity, and a negative impact on employee morale.

Because to the improved ergonomics during the roll-changing process and the decreased labour allocation.

### Why?

- To improve ergonomics to lower the number of mishaps, serious injuries, or fatalities when monitoring workers' locations in specific situations.
- To increase workplace safety, productivity, and employee morale.
- To prevent costly legal disputes and financial losses for the company brought on by accidents and injuries.
- To lower the amount of time lost due

to property damage accidents in order to improve the overall efficiency of the production process

### Needed action

The chance of rolls falling out of the hands is decreased when technicians use the jig because they come into less touch with the oily rolls.

### Horizontal expansion capability

This technique can also be used to replace other rolls on ZM machines, preventing technicians from coming into close contact

with an oily roll that could cause a slippage accident or damage to property.

These jigs are easily expandable and adoptable to be used in other facilities.

### Outcome

- Enhanced security for employees Jigs might lessen mishaps and injuries brought on by ergonomic or oil-slip issues.
- Productivity gains: By decreasing accident-related downtime and improving the roll changing process's overall efficacy, the jig can increase productivity.



## Keep Door Closed Strategy

### Member company

Bahru Stainless

### The Challenge

Most of the existing infrastructure predominantly focuses on automating operational, process and those critical areas, leaving non-operational and non critical spaces vulnerable to safety and security breaches as well as energy inefficiencies. The access door to those non-operational and critical areas become an important safety and security control point. However, automating the access door with safety barriers, sensors rise out the cost concerns.

**Expose to safety hazard and property damage :** Manual operation of doors in non-operational areas often results in doors being left open and closed

inadvertently, leading to significant injury or accidents to an employee and door damage. Most notably on windy locations where the door may be pushed or closed due to the environment. Moreover, the employee might be exposed to hazard from doors being inadvertently left open, exacerbating the factory's environment.

**Security Vulnerability :** Besides the safety concerns, non-critical and operational areas are often left unsecured due to the absence of automated door systems. This lack of security measures creates opportunities for unauthorized access, sabotage, endangering the safety of employees and assets.

The keep-door-closed strategy focuses on the access door for those non critical and operational areas to ensure all the access doors to be taken care of and no doors are left opened after they are used. It also

emphasizes on the practicability and cost efficiency for the strategy.

### Why?

**Operational Safety Continuity:** Ensuring the safety and integrity of non-operational areas contributes to uninterrupted operations. By minimizing the risk of disruptions caused by safety breaches , the factory can maintain production schedules, meet customer demands, and uphold its reputation for reliability and efficiency.

**Enhanced Security:** Implementing automated door systems in non-operational areas mitigates security risks by establishing controlled access points. By restricting entry to authorized personnel only, the factory can safeguard valuable assets, sensitive equipment, and proprietary information from unauthorized access or theft.

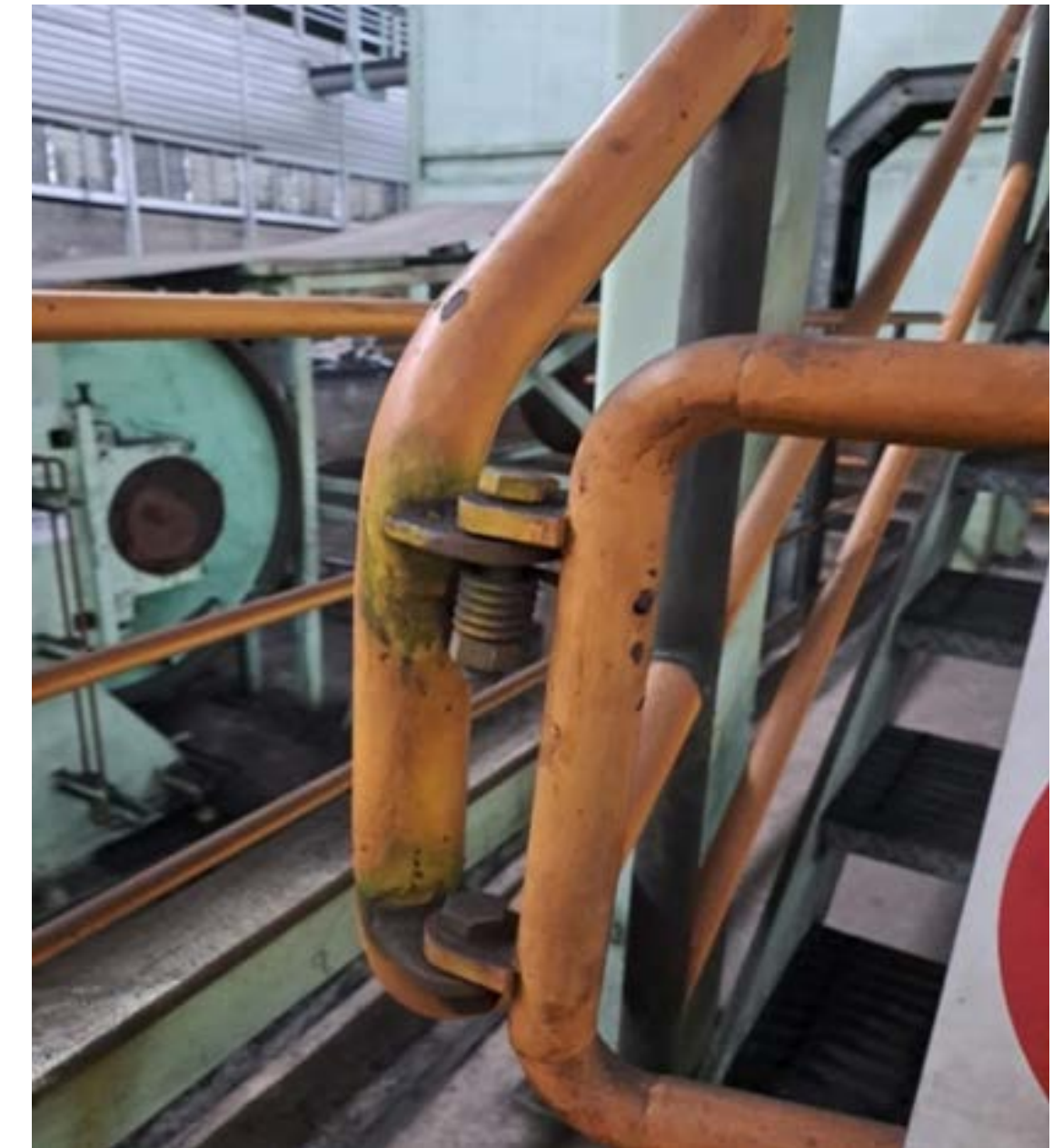

Spring Automated door closer

**Convenient to employees :** Ease maintenance team job by providing auto open and close door system since maintenance team sometimes need to bring equipments and related accessories



which make them unable to open and close the door manually.

**Standard non-operational area:** To make a conducive non-operational area with the tidiness of the area without an unattended open door.

### Needed action

**Design Development:** To conduct design development to identify suitable automatic door systems compatible with the environment and operational and safety needs

**Prototype Development:** To develop a prototype of the automatic door system tailored to the requirements of non-

operational areas, considering factors such as durability, resistance to harsh conditions, and ease of integration with existing security systems.

**Testing and Iteration:** To test the prototype extensively in simulated and real-world conditions to ensure reliability, efficiency, and safety.

**Installation and Implementation:** Once the prototype is refined, installing the automatic door systems in designated non-operational areas of the factory.

**Training and Awareness:** To provide training to employees on how to use the automatic door system and raise

awareness about the importance of keeping non-operational area doors closed.

### Horizontal expansion capability

The strategy of the keep-door-closed can be easily expanded based on different operational needs

### Outcome

**Enhanced Safety and security:** To minimized risk of unauthorized access to non-operational areas, thereby improving overall factory security.

**Energy Efficiency:** To reduced energy wastage by automatically closing doors

after entry, maintaining the controlled environment within the factory.

**Operational Efficiency:** To streamline the workflow by eliminating the need for manual door closing in non-operational areas, allowing employees to focus on their tasks.

**Cost Saving:** Instead of a high cost automated door closer such as safety barriers, sensors, this automated door to be more cost friendly.

By implementing this automatic door system, we can significantly enhance its security measures, optimize energy usage, and improve overall operational efficiency.



## Slab Cutter Access Control

### Member company

Columbus Stainless

### The Challenge

Whilst the continuous casting machine is casting, the slab cutter continuously performs slab cutting. During this process there is always the risk that a blow back could occur - the cutting flame does not penetrate through the slab and the subsequent liquid steel pool accumulates and is eventually ejected vertically out of the top of the slab.

This plume of metal droplets can cause injury to people walking over the access bridge that runs over the slab cutter.

The drive was therefore to improve the safety for the personnel that work in the continuous caster.

### Why?

The safety of our personnel in the plant is of paramount importance to us and due to this possibility of "blow backs" occurring we needed to make sure that our personnel are not in the vicinity to get hurt.

### Needed action

A brainstorming session was held with all disciplines involved in the plant and possible options were discussed.

The option that was determined to be the most viable was the implementation of a traffic light type warning system.

During times when the slab cutter is not cutting the light indication is green - it is safe to use the overhead cutter walkway.

As soon as the cutter is about to lower to initiate cutting the light indication turns



Normal slab cutting

red - no access to the walkway is permitted and personnel that are on the walkway have 20 seconds to get to a safe distance.



Walkway passing over the slab cutting area

### Action review

*Specific:* It was specific in terms of the aim that no personnel must be in any possible danger from flying sparks and steel during cutting.



**Measurable:** No incidents of injury due to sparks have been suffered.

**Achievable:** It was achievable and the team used opportunistic time to have the project done ahead of schedule.

**Realistic:** The tasks / steps that were completed for this system were:

- Install light units
- Pull in signal cable from slab cutter PLC
- Connect lights and signal relays
- Test system
- Full implementation
- Monitoring and optimisation

**Time-bound:** Project was completed well within the allotted time of 2 months.



"Blow Back" Event

### Horizontal expansion capability

It could be applied at our member companies as they also have slab cutting systems.

### Outcome

Improved personnel safety.



Green Robot at one of the walkway access point indicating safe passage

This has had a significant positive impact in terms of personnel morale in this section

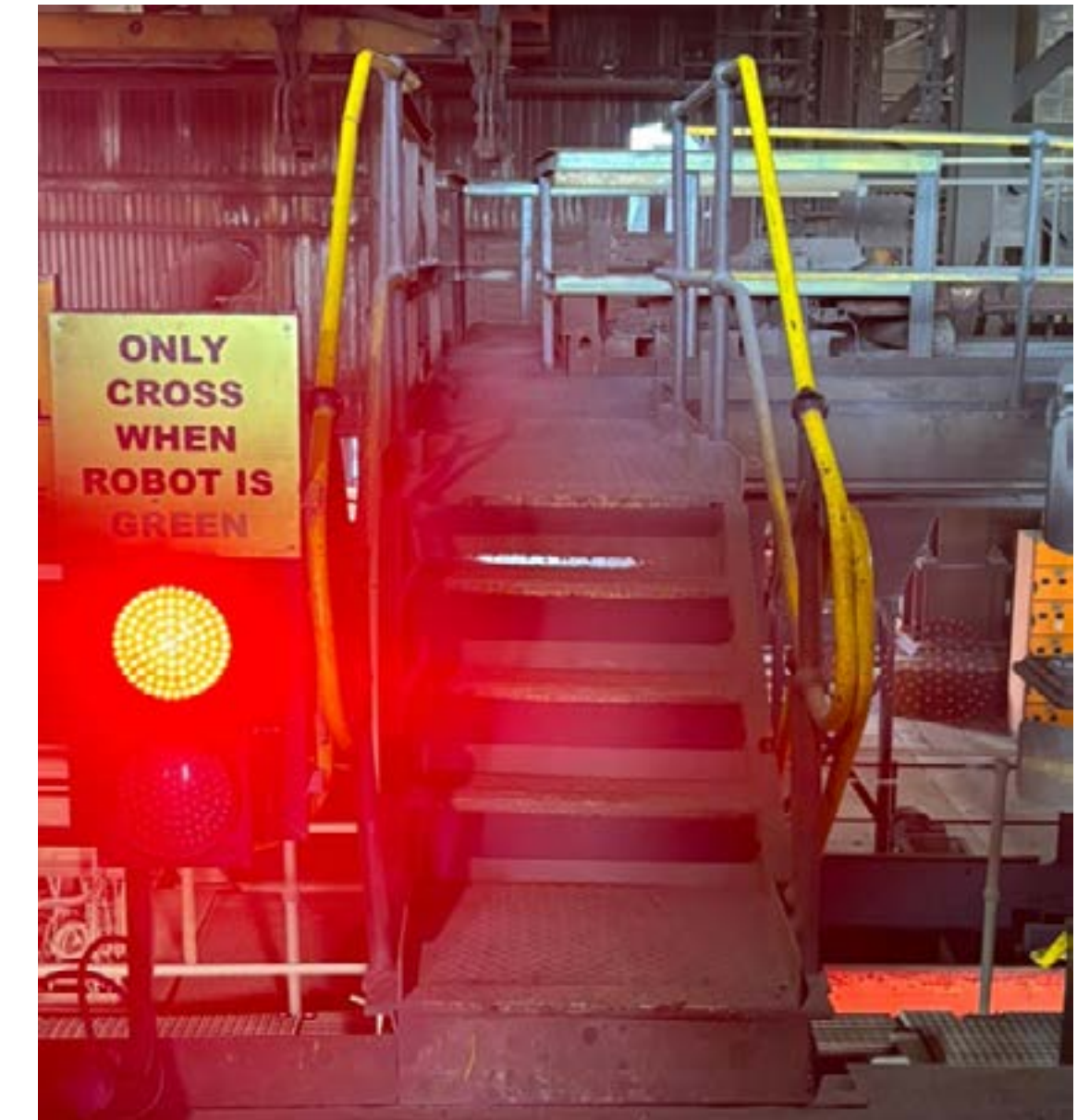

RED Robot indicating that cutting will commence - walkway is not safe

as they feel that the environment is now safer.



## AOD emergency recovery device

### Member company

Columbus Stainless

### The Challenge

If someone got injured or fainted inside the AOD during the refractory relining process, there was no quick recovery route to evacuate the person.

### Why?

When there is an injury or accident it is crucial that the recovery of that person can be done as effective and efficient as possible.

### Needed action

Installed a cross member (A-frame) which a hoist is mounted on. This can then move over the vessel to allow for a sturdy anchor point for a harness or stretcher to be

hooked on.

### Action review

*Specific:* The steps of the project were: Problem description, project definition, specifications, equipment requirements.

*Measurable:* An emergency drill was held to test the installed solution and it was found to be more than sufficient

*Achievable:* The project was implemented in time with minimal interference to normal operations

*Realistic:* There was enough space in the area to do the installation so there was not real obstacles



*Time-bound:* The project didn't overrun original planning

### Horizontal expansion capability

Yes, this can be applied to any refractory installation set up to allow quick recovery.

### Outcome

During the emergency drill it was seen that the solution greatly helped the Emergency Response Team. This made their job easier, more efficient and the possible

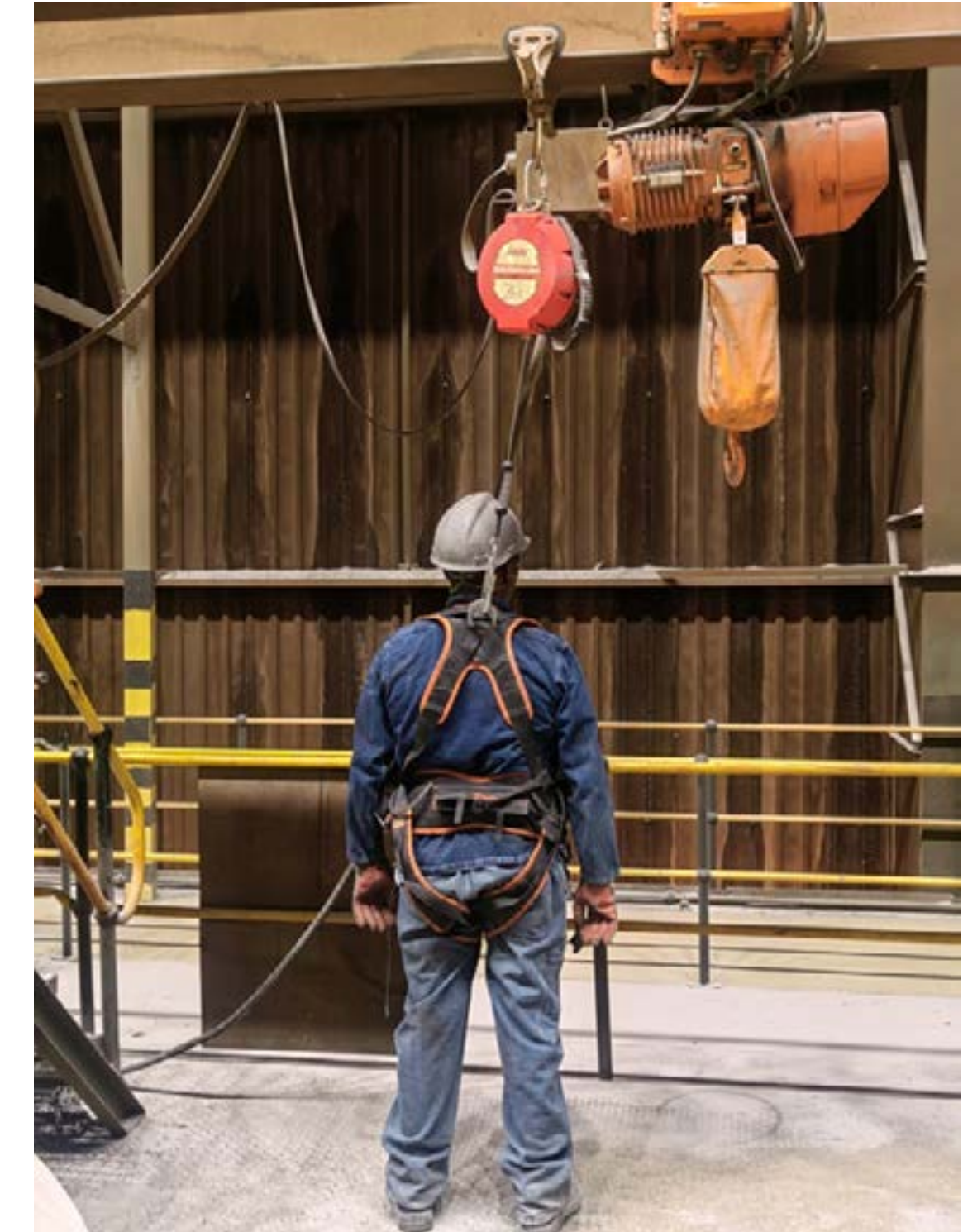

injured person could be recovered and attended to very quickly without sustaining further injuries.



## Ti drum lifter and feed chute

### Member company

Columbus Stainless

### The Challenge

The addition of Titanium drums into the steel at the ladle furnace is a very manual process and it puts strain on the operator's physique, so a better way had to be engineered to make the action easier and safer.

### Why?

As a safety drive it was tried to eliminate any manual lifting and handling of any material over 25 kg.

### Needed action

1. A cage was designed to place the pallet of Ti drum into and to ensure it can be safely lifted
2. A ramp/chute was put in place which

eliminated the need for excessive manual handling and to allow the drums to slide down to the additive chute

### Action review

**Specific:** The steps of the project were: Problem description, project definition, specifications, equipment requirements.

**Measurable:** After the implementation of this solution zero injuries have been recorded due to the addition of Ti drums

**Achievable:** A viable solution was put in place and is currently being used on all shift at the LMF

**Realistic:** All actions were realistic and achieved.

**Time-bound:** The project meant the timeline, with only minor improvements needed afterwards

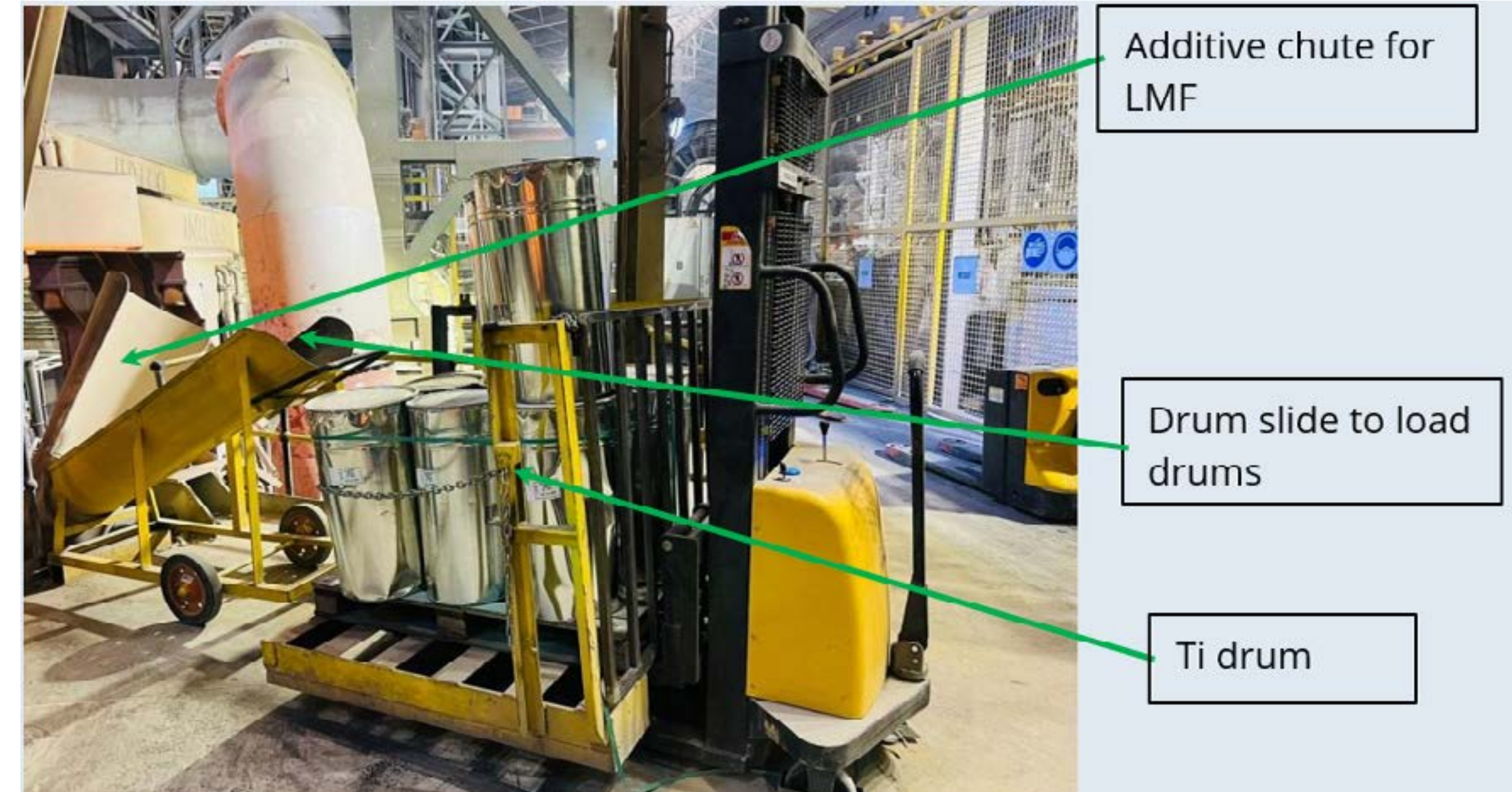

Additive chute for LMF

Drum slide to load drums

Ti drum

### Horizontal expansion capability

This was unique to Columbus as the sister companies use different methods which are not viable for Columbus' plant design/layout.

### Outcome

The action of loading the Titanium drums are now much less straining on the operators.



## Colour and sign signalling to improve identification of overhead crane movements

### Member company

Roldan S.A.

### The Challenge

We wanted to eliminate the confusion that an operator may have in the orientation and translation movements of the overhead crane depending on the position from which the operator looks at the overhead crane.

### Why?

Because we wanted to eliminate the root cause that generated an accident that occurred in November 2022.

### Needed action

We identify each orientation and translation movement of the overhead crane by painting each end with a color

and sign. On the other hand, we modified the stickers on the wireless control buttons, associating each button with the same color and sign as the end of the bridge crane that corresponds to it.

We have made this improvement in the 50 overhead cranes of the factory.

### Action review

**Specific:** This idea was proposed by General Services, due to the accident that occurred in November 2022 in order to eliminate the root cause that generated it: there are different possibilities of understanding the orientation of the movement.

**Measurable:** The actions taken were:

- Paint each end of all factory overhead cranes used by workers with a color and a sign.

- Identify each button on the wireless remote control with its respective color and sign of the end towards which it causes movement by means of stickers.

We had an accident in 2021 and another in 2022 related to this root cause. Since the modification we have achieved zero accidents.

**Achievable:** We have achieved the objective of this improvement, to eliminate the root cause that generated these accidents: there are different possibilities of understanding the orientation of the movement.

**Realistic:** The list of actions to be carried out was:

1. Paint a different color and sign on each end of 50 crane bridges.
2. Replace the movement indicator

sticker by personalized stickers with the appropriate color and sign on 50 wireless overhead crane controls and make a stock of these stickers.

**Time-bound:** We established a period of 1 year to carry out this improvement, avoiding interfering with production as much as possible.

This work began in August 2022 and was completed in August 2023, meeting the target deadline.

### Horizontal expansion capability

We have extended this improvement to all of the factory's overhead cranes used by operators.

We consider that this improvement in safety can be applied to all companies in which overhead cranes are used outside of automated processes.



## Outcome

Since we made this improvement, there have been no more accidents due to the confusion of the orientation and translation movements depending on the position from which the operator looks at the overhead crane.

Situation before the accident

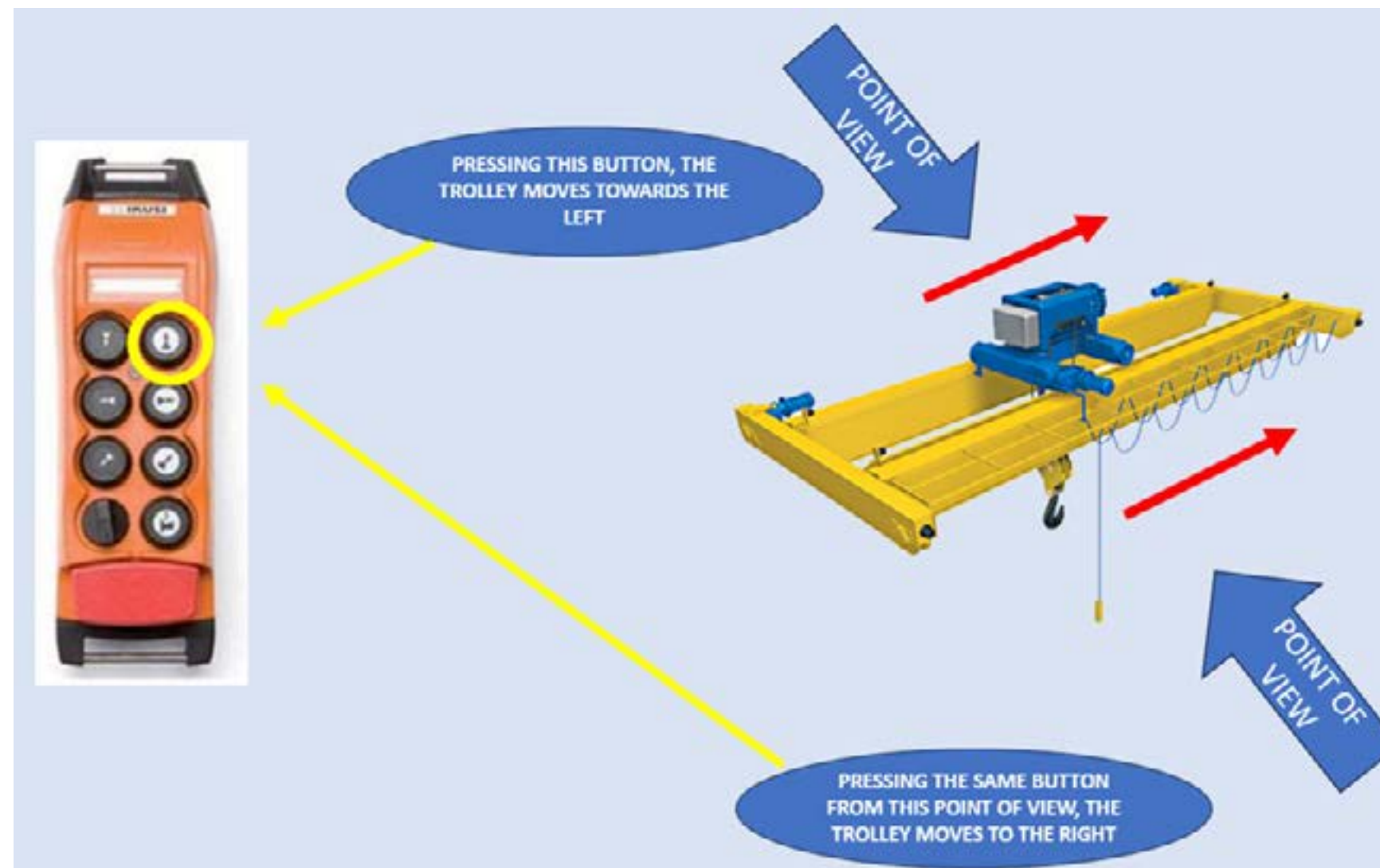

Post-accident situation

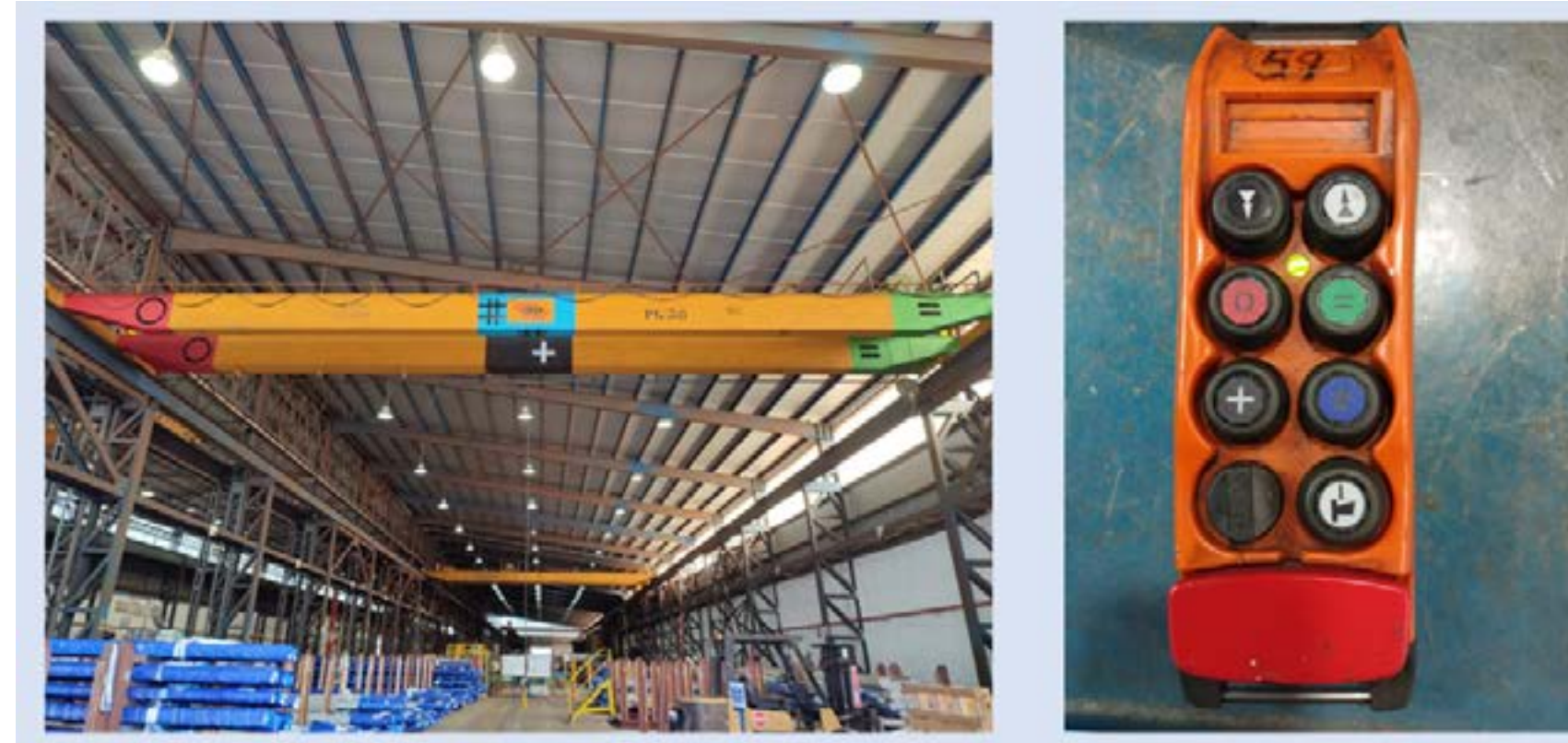



## Truck load securing chain checkers

### Member company

Columbus Stainless

### The Challenge

- Ensuring the correct chains is used to secure loads and prevent cargo from falling off the truck on national roads. (Chain breakage due to the incorrect diameter (8mm chains and less) being applied when securing loads).
- Ensuring chain integrity: chain failure due to excessive use.

### Why?

- Prevent serious road accidents due to cargo falling off the truck and onto national roads.
- Prevent truck and trailer damage due to cargo shifting back and forth on the

trailer

### Needed action

- Implement the use of only  $\geq 10\text{mm}$  thicker chains to ensure that loads are properly secured without the risk of breakage.
- The appointed Columbus logistics service provider C. Steinweg Logistics has designed a chain checker tool to inspect the chain diameter before loads are dispatched.

### Action review

#### Specific:

- As part of the final checks before a load can be dispatched from the Axle scale, the axle scale operator will inspect the chains diameter with the chain checker (Poka-yoke)



- The chain checker is marked with 8mm(Red), 10mm and 12mm (Green).
- If a chain is less than 10mm (Min

requirement) it will slide into the RED Zone which indicates that it's unsafe and must be replaced with a 10mm or thicker replacement. If the chain sits in the GREEN zone, it is safe for use.

#### Measurable:

Number of incidents related to cargo shifting or being loosened in transit.

All load securing chains are checked using this instrument when the delivery trucks are stopped at the Axle Scale for weighing



purposes.

*Achievable:* The chain checkers will prevent truck drivers from using damaged and elongated chains that may cause cargo to fall off the truck on national roads.

*Realistic:* Communication was sent to all external transporters with the updated critical requirements. Only trucks using  $\geq 10\text{mm}$  and thicker chains will be approved for loads.

The requirement is added to the transporter induction videos.

*Time-bound:* The design, manufacture and implementation of the chain checkers were  $\pm 6$  weeks.

## Horizontal expansion capability

This innovation can be applied to all loads where chains are required for securing loads.

## Outcome

No load securing chains incident has been reported since the checker instrument was implemented.



## Portable Lifelines for load securing and tarping

### Member company

Columbus Stainless

### The Challenge

The use of safety harnesses and lifelines for truck drivers when securing and tarping loads on the truck trailer in loading areas without a roofing structure.

### Why?

There has been an increase of truck drivers falling off the truck trailer while securing and tarping loads on site. This resulted in injuries to the truck driver.

Safety harnesses and lifelines were installed in loading warehouses with a roofing structure.

Loading warehouses without a roofing structure were still at risk for truck drivers

as safety harnesses and lifelines could not be easily installed.

### Needed action

Various options were explored to prevent truck drivers from falling off the truck trailer and getting injured in loading areas without a roofing structure.

The Columbus appointed logistics service provider C. Steinweg Logistics was instrumental in the design process of a Portable Lifeline (T-stand) to mitigate the risk of truck drivers falling off the truck. The T-stand was further designed to include a fitted ladder to allow truck drivers to safely climb onto the truck without any injuries.

### Action review

#### Specific:

- The truck needs to park next to the



T-Stands fitted with a fixed ladder and retractable lanyard for driver safety

- Portable Lifeline (T-stand)
- The driver fits on the safety harness and hooks it to the retractable lifeline
- The ladder pin is then released and the ladder is lowered onto the trailer deck. The driver ascends onto the trailer while secured to the retractable lifeline

**Measurable:** Number of truck driver

incidents since the installation of the portable T-stands: 0

**Achievable:** Logistics Safety Representatives are actively involved in training the truck drivers on how to use the Portable Lifeline. Compliance is continuously monitored. The use of the Portable Lifelines will form part of the Columbus transporter induction video.



### *Realistic:*

- The activity is not classified as a “working at heights” requirement as the maximum height of the truck deck is 1.5 meters from the ground. The Portable Lifelines and ladder installations serve as an extra protection tool to prevent truck driver injuries on site.
- A risk assessment was conducted by

- the Columbus management team in conjunction with Columbus Risk Control, Engineering fleet and C. Steinweg Logistics. Measures were put in place to ensure safety and compliance.

*Time-bound:* The design, manufacture and implementation time of the Portable Lifelines and ladder installation were  $\pm$  8 months.

### **Horizontal expansion capability**

The implementation of the Portable Lifelines has proven to be a safety milestone for truck drivers required to perform work on the truck trailers in all

loading areas. The designs of the Portable Lifelines and ladder installation have been shared with the Raw materials department to implement for truck drivers to safely remove cargo nets before offloading.

### **Outcome**

The risk of truck drivers falling off the truck deck and getting injured whilst securing and tarping loads has been minimized.



## Design and implementation of a new tool for the ignition of thermal lances

### Member company

Acerinox Europa S.A.U.

### The Challenge

The problem that ACERINOX EUROPA Prevention Service and Continuous Casting Staff is trying to solve is to prevent burns on operators during the ignition operation of a thermal lance.

### Why?

Some operators, sporadically, had suffered minor burns during the ignition operation of the thermal lance. The goal of ACERINOX EUROPA is 0 incident.

### Needed action

The action that has been implemented to solve the problem is to design a tool for the ignition of the thermal lances, so

that the risk for the workers is minimized. Until now, the procedure for lighting the thermal lances was carried out using cardboard cartridges, which are used for taking samples. (Fig. 1).

The procedure consisted of one operator regulating the flow of oxygen through the lance, while another operator approached and held the cardboard cartridge with flames at one end until the lance was ignited (Fig. 2), with the risk of burns and contact with hot substances.

With the development and use of the new tool (Fig. 3, 4) designed specifically for this operation (Fig. 5), accompanied with the corresponding work procedure (Fig.6), the aforementioned risks are eliminated.

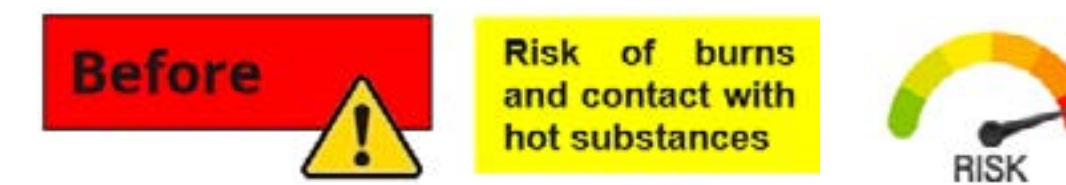

Fig. 1. Cardboard cartridges, which are used for the ignition of the thermal lances



Fig. 2. Method of ignition prior to tool development. Risk of burns and contact with hot substances

### Development of the project

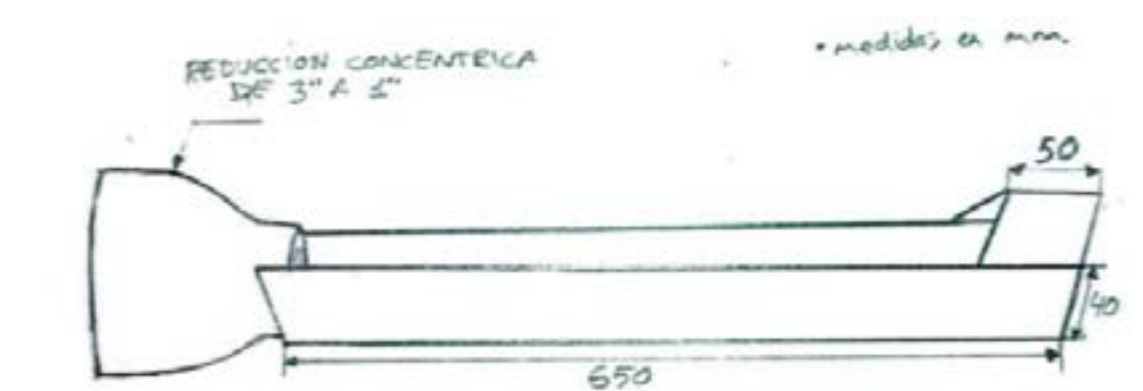

Fig. 3. Design of the tool (draw)



Fig. 4. Tool manufactured according to the design



**After**



**RISK**

Operator is at all times out of the radius of action during the ignition of the lance, avoiding the risks of burns and contact with hot substances



Fig. 5. New method developed for the ignition of the oxygen lances. This procedure avoid the risk of burns and contact with hot substances for the operators

ENCENDIDO DE LANZA DE CORTE		AREA	TURNO	FECHA	REVISOR
<p>Este procedimiento se aplica cuando se enciende la lanza para cortar.</p> <p>En el momento de uso de OXIGENO:</p> <p>1. Mantener el PPPI (presión) adecuada (40-50 PSI).</p> <p>2. Mantener la distancia adecuada (de 10-15 metros) respecto del punto de salida del OXIGENO.</p> <p>3. Mantener el flujo de OXIGENO constante.</p> <p>4. Mantener la distancia adecuada (de 10-15 metros) respecto del punto de salida del OXIGENO.</p> <p>5. Mantener la distancia adecuada (de 10-15 metros) respecto del punto de salida del OXIGENO.</p>		Carla Rodriguez Torres	Manuel Rojas Guerrero Ramirez		
OPERACION	ESQUEMA	<p>1. Preparar un sistema de tubo con caudal y válvulas en el momento de encendido.</p> <p>2. Realizar el encendido de la lanza de corte manteniendo permanentemente la válvula de apertura y cerrar el regulador y cerrar el PPPI (presión).</p> <p>3. Una vez que se enciende la lanza de corte, mantener la distancia adecuada (de 10-15 metros) respecto del punto de salida del OXIGENO.</p>			
<p>1. Preparar un sistema de tubo con caudal y válvulas en el momento de encendido.</p> <p>2. Realizar el encendido de la lanza de corte manteniendo permanentemente la válvula de apertura y cerrar el regulador y cerrar el PPPI (presión).</p> <p>3. Una vez que se enciende la lanza de corte, mantener la distancia adecuada (de 10-15 metros) respecto del punto de salida del OXIGENO.</p>		<p>Este procedimiento se aplica cuando se enciende la lanza para cortar.</p> <p>En el momento de uso de OXIGENO:</p> <p>1. Mantener el PPPI (presión) adecuada (40-50 PSI).</p> <p>2. Mantener la distancia adecuada (de 10-15 metros) respecto del punto de salida del OXIGENO.</p> <p>3. Mantener el flujo de OXIGENO constante.</p> <p>4. Mantener la distancia adecuada (de 10-15 metros) respecto del punto de salida del OXIGENO.</p> <p>5. Mantener la distancia adecuada (de 10-15 metros) respecto del punto de salida del OXIGENO.</p>			
FECHA DE ELABORACION	FECHA DE APROBACION	FECHA DE REVISION	TURNO A	TURNO B	TURNO C

Fig. 6. Safe working procedure for the ignition of oxygen lances

### Action review

**Specific:** the design and implementation of a tool for the ignition of oxygen thermal lances.

**Measurable:** A new tool and a work procedure have been implemented.

**Achievable:** The objective has been achieved.

**Realistic:**

- Study of the current procedure for the ignition of thermal oxygen lance
- Design of ignition tool
- Tool manufacturing and testing
- Implementation of the tool and development of the work procedure

**Time-bound:** All actions have been completed according to the time frame.

### Horizontal expansion capability

This action can be expanded within our company and applied within other member companies. The necessary technology is on the market. The project can also be expanded to other areas at the factory that use thermal oxygen lance.

### Outcome

After the implementation of the project, the benefit obtained is that the operation is being carried out under adequate safety conditions, eliminating the main risk of burns and contact with hot substances.

### Other comments

*"A simple and low-cost idea, can avoid serious safety risk situations"*



## Design and installation of a decontamination cabin at acid recovery plant

### Member company

Acerinox Europa S.A.U.

### The Challenge

It becomes necessary to improve the emergency procedure in the event of an incident with hydrofluoric acid operations, in terms of time, effectiveness and efficiency: optimising communication and alarm systems, establishing a suitable installation for an effective decontamination of the worker.

### Why?

Although there is a procedure for emergency and assistance in the event of an incident involving hydrofluoric acid, due to the hazardous nature of this substance, it is considered necessary to implement a decontamination cabin that reduces

the time spent on decontamination, ensures that decontamination is effective and can't be a means of exposing other people, ensuring the communication of the incident to the people assigned to the emergency: Shift Manager, Medical Service, Safety Staff, Section Manager, Security Staff.

### Needed action

The actions that have been implemented to solve the problem are:

- Analysis and study of the existing means in other factories.
- Design of the decontamination cabin.
- Installation of the decontamination cabin, fully equipped.
- Testing and commissioning period.
- Review of the emergency procedure.

### Action review

*Specific:* Design and implementation of the decontamination cabin, fully equipped, for incidents involving hydrofluoric acid.

*Measurable:* Realised or not.

*Achievable:* This is a clear and achievable objective at both technical and operational levels.

*Realistic:*

- Analysis and study of the existing means in other factories
- Design of the decontamination cabin
- Installation of the decontamination cabin
- Testing and commissioning period
- Review of the intervention procedure

*Time-bound:* All actions have been completed within the original time frame.

### Horizontal expansion capability

This action can be expanded within our company and applied within other member companies. The necessary technology is on the market. The project can also be expanded to other areas at the factory like acid storage areas and annealing and pickling lines. It can also be designed and used for other acids.

### Outcome

After the implementation of the project, the factory has its own design decontamination cabin developed with the participation of the workers, workers representatives in safety matters, Acid Recovery Plant Staff, Prevention Service, Maintenance and IT Staff.



The acceptance of the workers has been excellent, and all the periodic tests and simulation exercises that have been carried out have been satisfactory, reaching the established objectives and goals.

The cost of investment is low and all the elements and technology are on the market.

### Other comments

The sequence of emergency starts when the yellow door is pushed by the operator who may have been splashed with hydrofluoric acid.

Activating automatically: shower, light/audible alarm, a notice is sent via telephone to Medical Service, Shift leader, Safety Staff, Security Staff, Section Manager.

In addition the cabin is equipped with: electrical boiler, eyewashes, hexafluorine autonomous portable shower, hexafluorine eyewash, telephone call equipment, bench and clothes to change.



EMERGENCY SHOWER. PUSH.

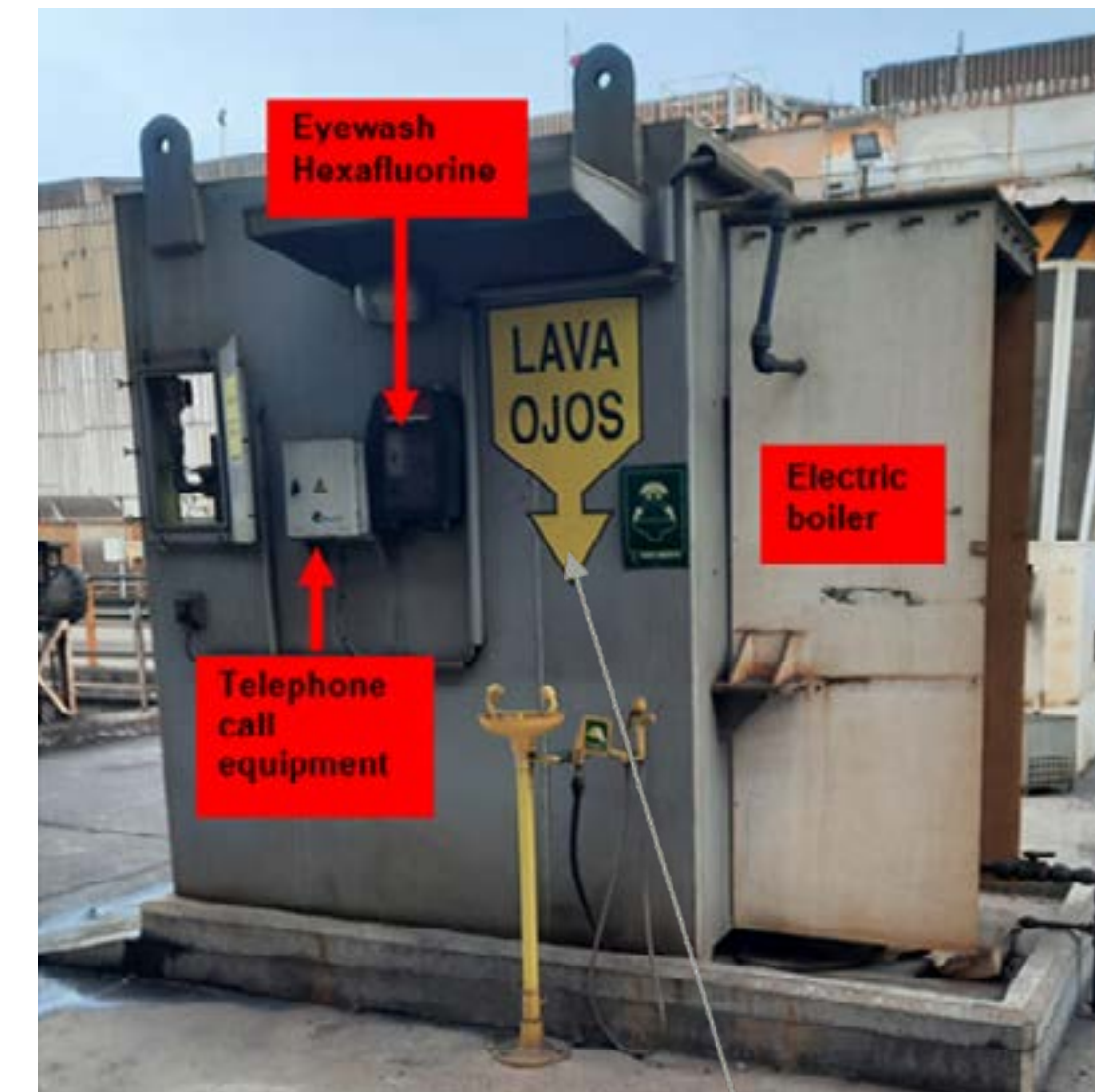

EYEWASH



Fig. 1. General view of the decontamination cabin and description of cabin components





Fig. 2 Details of components in the decontamination cabin

	<b>INSTRUCCIÓN DE TRABAJO</b>	IT-LF-035
	<b>CABINA DE DESCONTAMINACIÓN HF</b>	Rev. 0 Hoja 1 de 7

**INDICE**

1. OBJETO.
2. ALCANCE.
3. DESCRIPCIÓN DE LA CABINA.
4. FUNCIONAMIENTO.
5. MANTENIMIENTO.
6. RESPONSABILIDADES.
7. REFERENCIAS Y ANEXOS.



0	Emisión	29/11/2023
<b>REVISION</b>	<b>ALCANCE</b>	<b>FECHA</b>
Realizado: Sección de Recocido 	Aprobado: Jefe de Departamento LF 	
Nombre: A. Bocardo / A. Ruiz	Nombre: Javier Mielgo Benavides	

Fig. 3. Work instruction developed



## PackSolve Plate Lifters Safety Improvement

### Member company

Columbus Stainless

### The Challenge

We had a number of incidents where the long plates shifted while being transferred from one area to another with an overhead crane and that posed a threat to the health and safety of our employees.

### Why?

We have decided to address the risk as the health and safety of our employees are of utmost importance and also to protect the steel products from scratches.

### Needed action

- PackSolve experienced a total of seven (7) high potential incidents in the past three (3) years, where the crane lifter

swung and material slid off the plate lifters and others where the plate lifter unhooked from the skids. All these incidents triggered a risk review in which various controls introduced were inadequate and resulted with the current modifications.

- We have installed adjustable stoppers on all sides of the plate lifter to stop the material from shifting while being transferred from one area to another. We went further to extend the lifting feet of the lifter as well to keep the load more stable during transfer by overhead crane.
- The feet of the lifter were extended with 60mm. The original length was 130mm and the modified lifter feet are currently 190mm.
- See the pictures below for reference :



Feet before modification



Feet after modification



Loads transfers before modifications



Loads transfers after modifications



## Action review

Specific: We had a specific need to try and eliminate the occurrences where the material slips while transferring from one area to another. We have thought about installing a vice like attachment to the lifter but that would cause more scratches on the material as the load will still shift and the pressure from the attachment will cause dents. We came up with the extensions on the lifter that still allows the load to move with the lifter but at the same time keep the material safe from slipping.

### Measurable:

- High repetitive number of incidents for cases falling
- The lifter made no provision for the

cases to be secured from all 4 sides.

- High number of NCRs in proportion to cases falling
- High number of reworks related to falling cases
- Delayed on-time deliveries (damages to material)

### Achievable:

- New improved design acts as a poka yoke device as it prevents crane drivers from handling more than 2 cases at a time
- Lifter now makes provision for the cases to be secured from all 4 sides.
- Eliminate the possibility of the cases sliding off.

### Realistic:

- Reduced number of NCRs in proportion to cases falling
- Reduced number of reworks related to falling cases
- Improvement of on-time deliveries
- Reduced the number of canceled orders.

*Time-bound:* The lifter modification project took a little time longer than initially planned due to manufacture error while installing the adjustable stoppers fastening levers. The lifter had to be returned for the error to be rectified and since it was returned, it worked well with no incident experienced.

## Horizontal expansion capability

This modification can be applied by companies using 3m plate lifters to transfer material safely from one area to the other.

## Outcome

Since the implementation of the extensions on the plate lifter, we experienced no incident where plates shifted or endangered the safety of employees involved. This also resulted in fewer scratches on the product and more prime material moved out to the customers.



## Improvements in material movements: poles to avoid touching material with hands

### Member company

Roldan, S.A.

### The Challenge

We wanted to avoid touching loads with hands and this way eliminate the risk of entrapment that may occur from this task.

### Why?

Because we wanted to eliminate the root cause that generated several accidents in 2022.

### Needed action

The first action was to look for an already designed and commercialised pole for such a task in the many catalogues of working tools.

The second action was to design a pole using the ideas that were provided by

the workers and staff area. We needed a design adapted to our work process, it had to be very light and with a rubber handle for a better grip. The tips also had to have some type of protection to avoid damaging the load.

### Action review

*Specific:* This idea was proposed by the Finishing area, due to several accidents in 2022 in order to eliminate the root cause that generated it: <handling loads>. One of our company's cardinal rules is "hands off" the loads, so we also needed something to comply with this regulation. The first step was to look at the commercialised poles to see if they adapted well to our work conditions. As this was not the case, the second step was to look into our real needs and gather from the workers all the information about the real working

conditions. From this information a prototype was elaborated and tried out.

*Measurable:* The actions taken were:

- Place a pole in all the working posts where needed.
- Eliminate the percentage of accidents due to moving material

*Achievable:* We have achieved the objective of this improvement, to eliminate the root cause that generated these accidents when moving material. Now the workers can keep the policy of "hands off" when moving material, complying with the company policy and avoiding accidents.

*Realistic:* The list of actions to be carried out was:

1. Find the most adequate tool for the task

2. Place them in the needed working posts.

*Time-bound:* From the moment in which the perfect design was achieved, a one month period was established to provide them in all the working posts where needed, that is to say, in all the working positions where the operator needed to move material. The pole was first established in the Finishing Shops, but shortly after was also used in the Rolling Mill area and Dispatching section.

The deadline was met and to this date the pole is being used in all the work posts where material movements occur.

### Horizontal expansion capability

We have extended this improvement to all of the work posts in our Factory where material is moved.



We consider that this improvement in safety can be applied to all companies in which material is moved and there is danger of hand entrapment.

### Outcome

Since we made this improvement, there have been no more accidents due to material movement. The workers can safely move the material bundles without using their hands

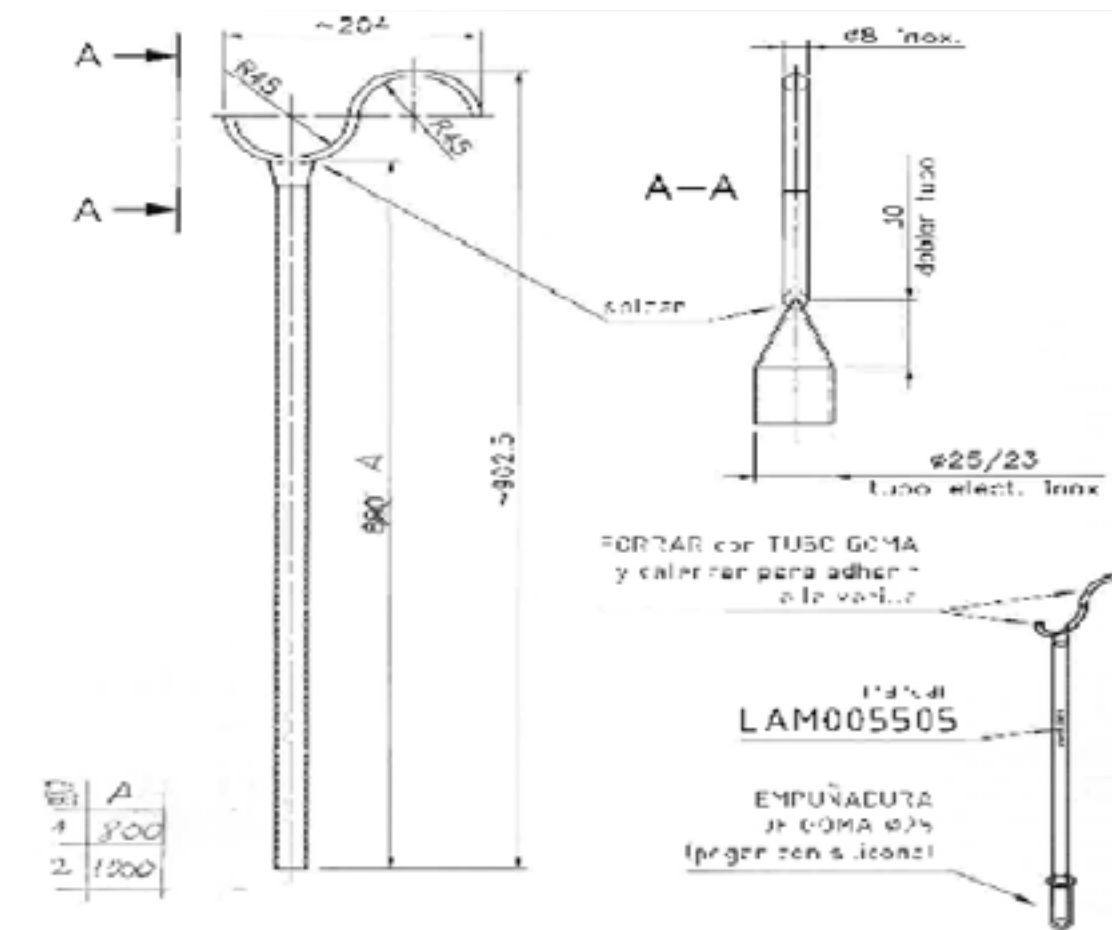

Pole design

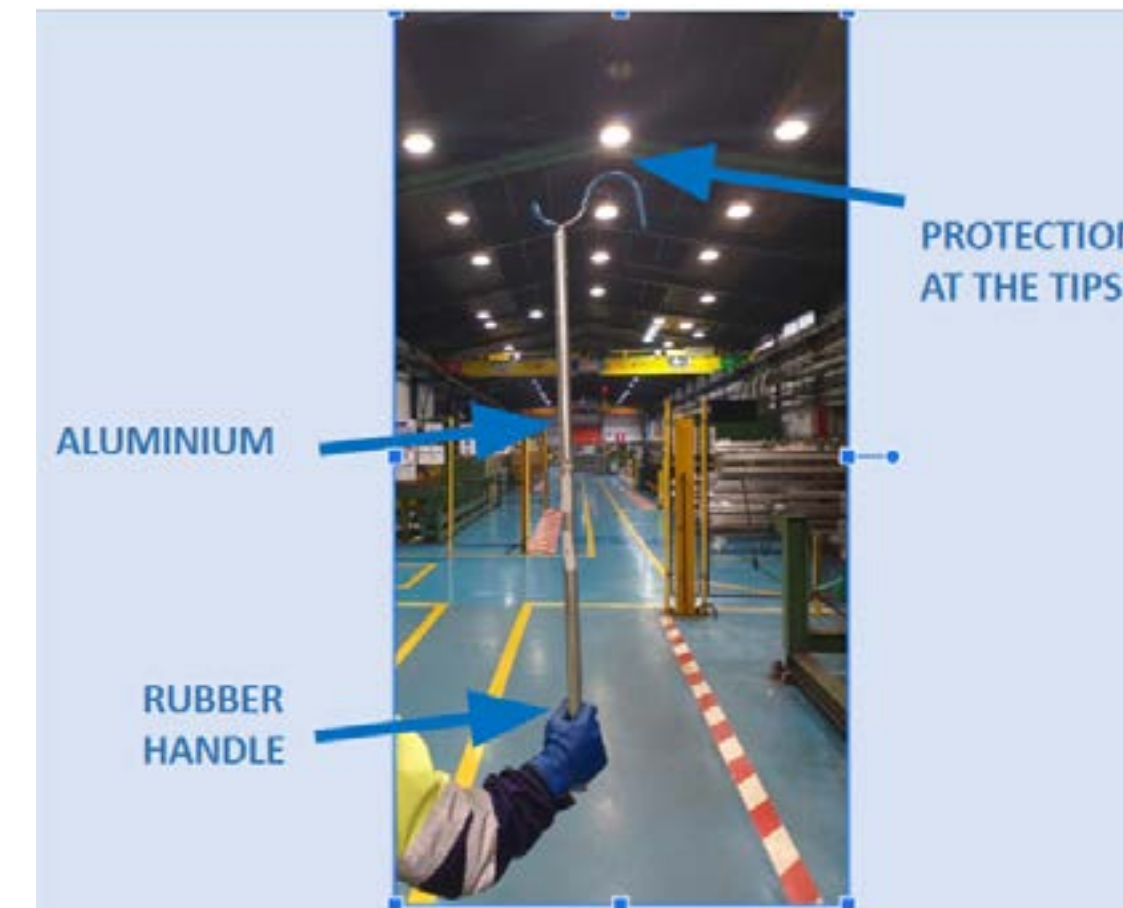



## V-belt Drive-train Manipulating Tool

### Member company

Columbus Stainless

### The Challenge



V-belt driven equipment often requires a manual test after assembly or during fault finding. The driver (motor) is first isolated, locked out, tagged and tested for

no motion. The drive-train needs to be manually pulled back and forth to determine whether there is a bearing, coupling or fan impeller fault. Traditionally an artisan would grab the v-belt and pull

and push to move the drive train, but there is a nip-point and the risk of injury.

### Why?

An injury occurred where an artisan pulled their hand into the nip-point and pinched their finger.

### Needed action

Develop a simple easy to use tool that an artisan can use to safely manipulate the drive-train back and forth while fault-finding.

### Action review

*Specific:* The v-belt manipulator tool was conceptualised, manufactured and tested. Different sizes of the tool are required depending on the cross-section of the



v-belt. Five different sizes were designed for Columbus engineering requirements.

*Measurable:* There has not been a similar injury for more than 6 months

*Achievable:* The objective of removing the person's hands from the nip-point while still being able to easily manipulate the drive-train, was achieved.

*Realistic:* The actions required were

straight-forward. Drawings made of the five sizes and the tool was made stock in the Columbus Store to be used as an when required.

*Time-bound:* The solution has already been implemented

### Horizontal expansion capability

The tool can be made and used throughout our company and any other company.

### Outcome

The primary benefit is artisan safety but the simple and easy-to-use design has initiated a new behaviour to solve other problems in a simple and easy-to-use manner.



# Inversed placements of bolt and nut : Improvements for electrode replacement work in sulfuric acid electrolysis tank

## Member company

Nippon Yakin Kogyo Co., Ltd.

## The Challenge

At the Kawasaki Plant of Nippon Yakin Kogyo Co., Ltd., annealing and pickling processes are carried out on the “AP line”, an equipment designed to chemically remove scale of coils. Within this line, there is a sulfuric acid electrolysis tank which contains electrodes (Fig. 1).

These electrodes require replacement as they corrode or suffer from tears and swelling of their lining. They are installed from the floor covering, fixed with bolts through the top plate. The replacement work requires two people, where one must enter a very narrow space underneath the floor covering to prevent the nut from spinning when unbolting.

## Why?

This space has no scaffolding and involves working on H-shaped steel, posing a risk of falling. Additionally, there is a risk of dust entering the eyes or coming into contact with acid crystals (Fig. 2).

## Needed action

At first, we tried to solve the problem by improving the structures under the floor covering, or modifying the floor covering itself. However, these improvements didn't eliminate the need of workers to enter underneath the floor covering.

Then we thought of an inversed way of placing bolts and nuts, where the bolt is passed from UNDER the floor covering and the nut is tightened on the TOP so that no one has to go under the floor covering. However, this could cause the bolt to fall during its replacement, since only one nut is applied on the top plate to hold the bolt.

Therefore, we thought of adding another nut on the lateral plate to prevent bolts from falling. With this method, the top plate and electrodes can be replaced by only removing the nut on the top plate,

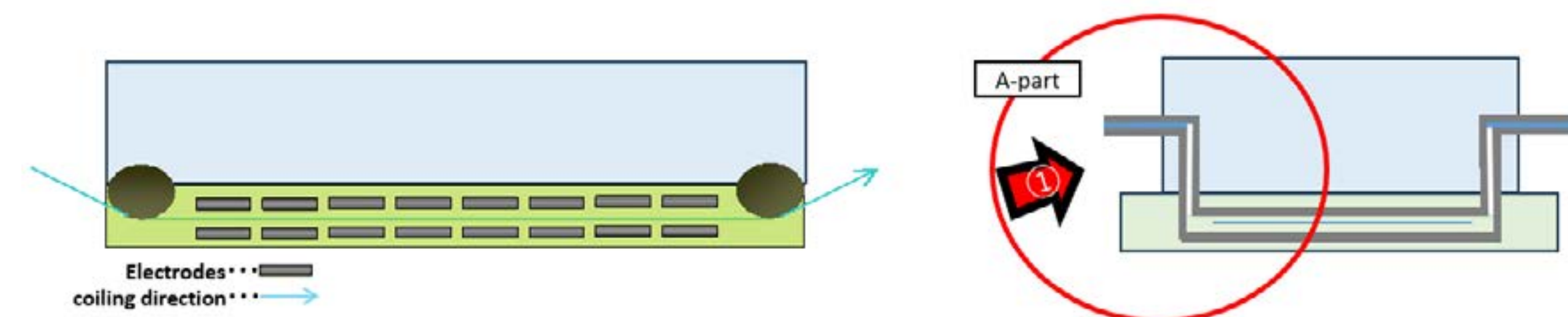

Figure 1: Cross section of sulfuric acid electrolysis tank

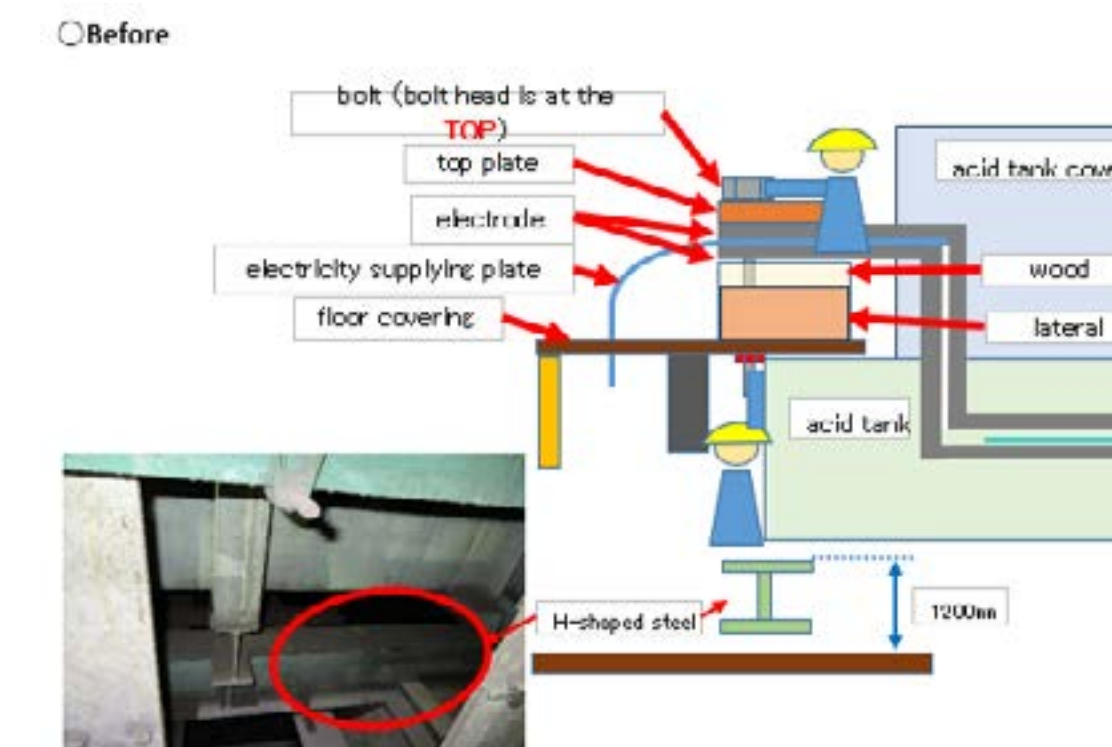

Figure 2: Before improvement (A-part in detail)



allowing for easy, safe, and single-person replacement without entering under the floor covering (Fig. 3).

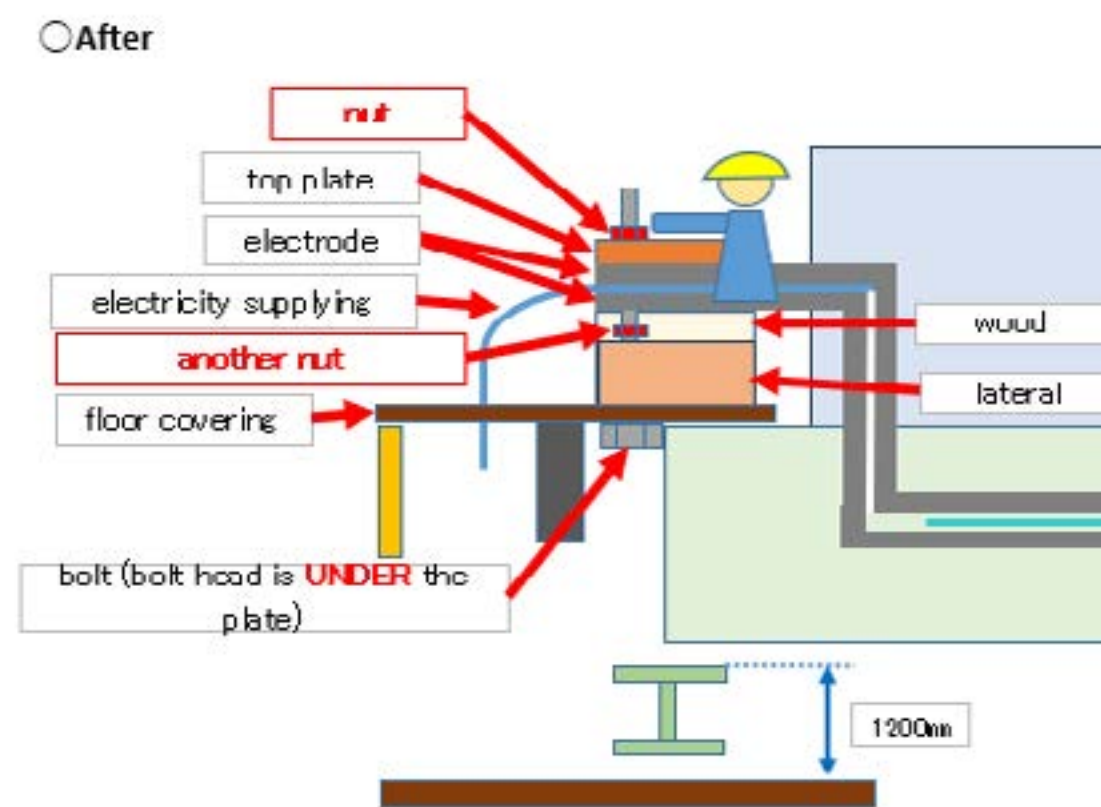

Figure 3: After improvement (A-part in detail)

This method has now been applied to all electrodes in this equipment (Photo 1 and

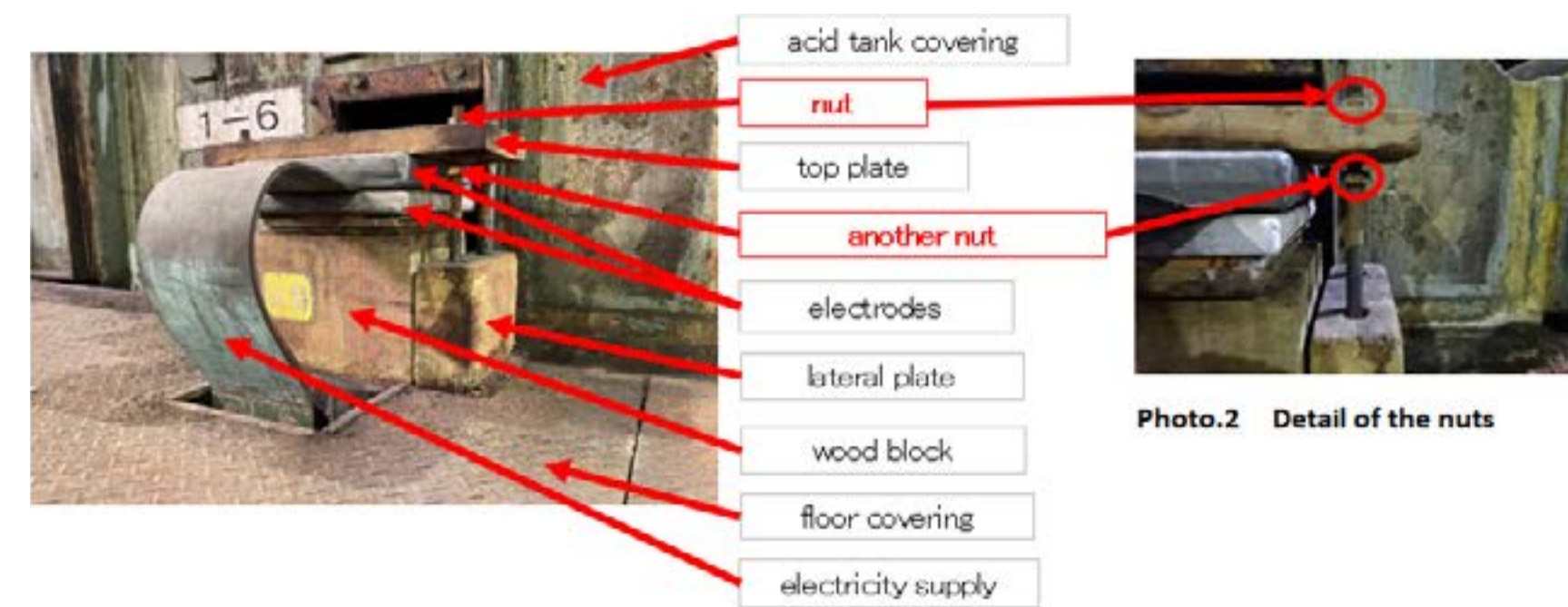

Photo. 1 Electrodes after improvement (from ①-direction)



Photo. 2 Detail of the nuts

2).

### Action review

*Specific:* The electrode replacement work used to be conducted underneath the floor covering, so its operational risk was high.

Therefore the electrode fixing method

itself was changed so that no one has to work in narrow and unsafe place.

### Measurable:

- The number of workers was reduced from two to one.
- Working hours

for the replacement were reduced by around 12.0hrs/year.

- Working efficiency was improved.

### Achievable:

- No more working in areas without scaffolding: eliminating the risk of falls.

- Health risks of dust coming in the eyes or contact with acid crystals have been eliminated.

*Realistic:* When replacing electrodes, the top plate and electrodes can be removed by only removing the nuts on the top plate. Now that one person can easily replace the electrodes without going under the floor covering.

*Time-bound:* three months

### Horizontal expansion capability

If similar replacement work is being done in equipments with similar structures, the same improvements can be applied.



## Outcome

This improvement has not only eliminated the need to work under the floor covering but also removed the risks of falling, dust entering the eyes, and contact with acid crystals. Furthermore, it allowed for single-person operation on top of the floor covering, leading to a reduction in operational time. The Risk Assessment rating improved from level B to level D (Table 1).

### ○ The results

**Table. 1 Risk Assessment**

Risk Assessment	Before	After
1. The magnitude of injuries	8	0
2. The possibility to come across with the danger	2	0
3. The difficulty of avoiding injuries	2	0
Total score	12	0
Risk Level*	B	D

\*Risk Level

Level	Score	Description
A	15-20	Prompt improvement shall be conducted
B	12-14	Improvement priority is high
C	9-11	Improvement plan is needed
D	0-8	Residual risk remained



# Sustainability Case Studies





## Seal Water Improvements and Reuse

### Member company

### North American Stainless

### The Challenge

Excessive water usage and losses.

### Why?

Visual waste of water in acid pickling sections and the desire to conserve natural resources that are being depleted.

### Needed action

In early 2023, ball valves were installed on the discharges of seal water for acid pumps and throttled back the amount of water flowing from the seal, while still maintaining effective pressure on the seal. Later in the year there was also a new style of pump, magnetically driven, that allowed for further in water usage.

### Action review

*Specific:* NAS conducted bucket tests on the seal valves in our Long Products facility to estimate the water usage. Based on these findings, ball valves were installed on the discharge off of the seal from the acid pumps. The ball valves restricted the flow coming from the seals in the acid pumps and reduced the amount of water needed for the seal. The discharged water which previously discharged to wastewater for treatment was rerouted to the rinse tanks for a secondary use. One large pump which previously required seal water was replaced with a magnetically driven pump that does not require water for pressure on a seal.

*Measurable:* River water intake numbers were compared from 2022 to 2023, as well as the numbers for gallons per ton of steel.

The total quantity of water withdrawn from the Ohio River was reduced by 236 million gallons. The average water withdrawal was reduced from 976.71 gallons per ton of steel cast in 2022 to 877.16 gal/ton for 2023.

*Achievable:* Yes, the intended result was achieved. There was a reduction in water withdrawn from the river for use in process.

*Realistic:* These tasks that were accomplished were realistic due to the waste of water being a visual and known thing. The reduction of water was easily obtainable once the issue was discovered.

*Time-bound:* The initial install of these ball valves did take some time, but was accomplished within a month after meetings over this project had commenced. The magnetically-driven

pump was then installed 3-4 months after the ball valves were installed. There are still ball valves, or other means for flow restriction, that need to be installed around the site. Which would further aid this project.

### Horizontal expansion capability

Yes, anywhere that utilizes water to maintain pressure on a seal or to lubricate packing can either be recycled or throttled back on the discharge end of the pumps packing gland or seals. Most of this water is clean water that is being passed through an uncontaminated portion of a pump. On acid pumps, water discharged from the seal should be regulated and can be reused but understand that in the case of a seal failure that it could result in acid going to the point of reuse.



## Outcome

For quantified outcomes, please see the attached document. The benefits of this project have contributed to the health and well-being of employees by reducing the amount of water being contaminated in the local area, thus making a positive impact to the communities surrounding NAS. This has also improved job satisfaction for those that have been involved in the project by giving a sense of accomplishment by contributing to the conservation of natural resources. As for the rest of the parameters that are listed, this was a low-cost project which utilized plastic piping and ball valves with a large return through reduction of water being pumped and treated.

## Other comments

This is an on-going project that will be continued around the site, and has the potential to yield even better results than we have already seen. This project has resulted in individuals around site collaborating to achieve the goal of water reduction, while NAS continues to grow along with its demand for water usage on site.



## Chemical tankers using SUS329J1(NSSC™2351)

### Member company

**Nippon Steel Stainless Steel Corporation**

### The Challenge

Chemical tankers have a significant role in transporting liquid chemical products used in the petroleum and chemical industries. In particular, chemical tankers that carry highly corrosive cargoes such as sulfuric acid and nitric acid use stainless steel for cargo tanks. In the past, chemical tankers built in Japan have mainly used Type316L austenitic stainless steel, but in recent years, soaring prices of rare metals such as nickel and molybdenum, the main components of Type316L, have become a major issue in ship construction. Since the application of S32205, which contains less nickel than Type316L, has become popular in chemical tankers in overseas

shipyards, we developed NSSC™2351. This grade is a duplex stainless steel which is equivalent to SUS329J1, and while further reducing nickel and molybdenum from the existing duplex stainless steel, its corrosion resistance is as same as that of S32205.

### Why?

Since nickel, molybdenum used in stainless steel like are rare metals, the prices often fluctuate wildly under the influence of market conditions. As prices fluctuate, the price of stainless steel also fluctuates, which may make it difficult for consumers to purchase stainless steel.

To avoid this situation as much as possible, we have reduced the amount of rare metals used to reduce the price fluctuations so that customers can purchase stainless steel with confidence.

### Needed action

In the development of resource-saving duplex stainless steel, the following four points were positioned as major issues to be solved.

1. Corrosion resistance equivalent to existing steel grades S32205 and Type316L.
2. Reduce the use of rare metals such as nickel and molybdenum to stabilize steel prices.
3. Reduce the amount of steel used by



taking advantage of its higher strength compared to Type316L.

4. Enable welding with high heat input to improve efficiency of welding work in shipyards.



## Action review

*Specific:* We have abundant experience in manufacturing Type316L and S32205 used for chemical tankers and applied this experience and knowledge to development a resource-saving duplex stainless steel NSSC™2351(23Cr-5Ni-1Mo).

The welding process is essential in the construction of chemical tankers. While duplex stainless steels are generally considered difficult to weld with high heat input, NSSC™2351 makes this possible

and improves work efficiency in shipyards. In addition, the corrosion resistance and strength of the welds were also improved compared to Type316L.

*Measurable:* Chemical tankers built by Kitanihon Shipbuilding

Ship name : "SPARROWHAWK" and "SUNBIRD" (These are the same size).

Size: 22,000 DWT

Number of vessels : 2

Steel consumption: 2,600 tons

*Achievable:* Already in service from

October 2023.

*Realistic:* Already put to practical use

*Time-bound:* Already put to practical use

## Horizontal expansion capability

We have already obtained the certification from the Nippon Kaiji Kyokai (CLASS NK) and Korea Maritime Association (CLASS KR) for this application, and aim to apply the certification to chemical tankers of other shipyards.

## Outcome

The adoption of resource-saving duplex stainless steel for chemical tankers has made it possible to reduce the amount of rare metals used and to reduce the plate thickness for strength of the steel material. As a result, we could also reduce CO<sub>2</sub> emissions by reducing the overall weight of the chemical tanker.



## The Shikishima Water Tower, Maebashi, Gunma

### Member company

### Nippon Steel Stainless Steel Corporation

### The Challenge

Japan's water utilities are facing a number of issues, including decreasing revenue from the amount of water being distributed due to the declining population. In particular, renewing aging facilities and strengthening resistance against earthquake damage have become urgent issues as the number of severe disasters have been occurring more frequently in recent years.

In Maebashi City, Gunma Prefecture, many of its water supply facilities are aging and need to be replaced. The city planned the renewal of the Shikishima Water Tower as part of a policy to build water facilities that

are disaster-resistant, safe and stable, as well as being easy to maintain.

The new water tower is required to be as tall as the old tower, and also to be durable, earthquake resistant, and easy to maintain. In addition, the old water tower that was designated as a national tangible cultural property had been in use for over 90 years. It had long been a familiar local landmark, so the new tower similarly needs to be a symbol of the city.

### Why?

Although most water distribution reservoirs (including water towers) in Japan were made of concrete, an increasing number of them have been replaced with stainless steel construction since 2000. The reason for this is that stainless steel is an ideal material for storing drinking water due to its hygienic properties and

durable, corrosion-resistant features. Using stainless steel will result in simplified maintenance that can ease the burden on facility management.

In addition, since facilities made of stainless steel do not need painting, the appearance is not ruined by the deterioration of the paint, and it remains attractive over a long period of time. We believed that making use of these beneficial characteristics of stainless steel can help to solve the problems facing Maebashi City.

### Needed action

Maebashi City had never used stainless steel in its water towers, so it was necessary to have the city understand the benefits of using stainless steel. Therefore, we explained that an increasing number of water utilities are adopting stainless steel







for the water facilities. We demonstrated the superiority of stainless steel in comparison to other materials such as SS (Steel Structure), RC (Reinforced Concrete) or PC (Prestressed Concrete). In addition, we explained that stainless steel tanks have advantages for building tall structures such as water towers, especially in terms of structural planning, construction processes and maintenance.

In conventional construction methods such as RC and PC, the material thickness increases in order to enhance the cross-sectional performance of the structure, resulting in a heavier frame. Furthermore, since many processes are necessary during on-site construction, there is a risk of quality deterioration depending on the skill level of the construction managers and engineers. Finally, conventional construction methods require periodic

renewal and maintenance of the interior and exterior, which results in increased maintenance costs.

In contrast to other alternative materials, stainless steel is lightweight, which reduces the load on the ground. Standard materials can be produced under strict quality-control at a factory to the highest standards, and can be suitably shaped for on-site construction before being delivered to the site. This enables construction plans to be more flexible and ensures high quality. By using an optimal type of stainless steel for the environment where the component is to be used, it is possible to make the most of the material properties such as corrosion resistance and durability.

Even after completion of the construction, the appearance can be kept up through simple cleaning, making it easy to maintain



the facilities. This can be expected to extend the lifespan of the facilities and reduce life cycle costs.

### Action review

*Specific:* In the gas phase inside the water tower, water droplets on the ceiling become acidic due to the dissolution of evaporated chlorine gas, which can damage the passive film of stainless steel and cause pitting corrosion. For this reason, SUS329J4L, a duplex stainless steel with high pitting corrosion resistance, is used for the parts in the gas phase.

For the liquid phase, SUS304A is adopted. This has high workability such as bending, drawing, and welding, and also has sufficient toughness and corrosion resistance. With regards to the appearance, in order to produce a uniform tone, after being fully polished, the

surface of the material was shot blasted and pickled. The stairs and viewing deck installed on the tower are also made of stainless steel.

*Measurable:* The new Shikishima Water Tower is made of stainless steel and uses 15 tons of SUS329J4L and 155 tons of SUS304A. It is 12.7m in diameter, 37.7m in height and has an effective capacity of 1015m<sup>3</sup> (total capacity 3640m<sup>3</sup>). The height is almost the same as the old tower, so water can be distributed at the same water pressure as before. The total capacity has been expanded beyond the 1015 m<sup>3</sup>, and this increased capacity is used to prepare for possible disaster.

*Achievable:* Construction was completed in February 2021.

*Realistic:* The new tower is already put in service.

*Time-bound:* The construction started in July 2019 and was completed in February 2021 as scheduled.

### Horizontal expansion capability

Due to publicity over the Shikishima Water Tower from the website of Maebashi city and the promotion of water facilities using stainless steel on TV and water industry newspapers, cylindrical tower-shaped water distribution reservoirs made of stainless steel are becoming more widespread in Gunma Prefecture. In Japan, stainless steel is being adopted for more than two hundred water distribution reservoirs, including other shapes such as rectangular tower, and it is expected that stainless steel will be used in many more facilities.

### Outcome

Stainless steel water reservoirs are sustainable and resilient water facilities, and is one solution to the problems which Japanese water utilities are facing. The Shikishima Water Tower is recognized as a safe and durable facility that can serve as an important base for emergency water supply activities during disasters.

### Other comments

The Shikishima Water Tower is the third tallest stainless steel water tower in Japan. The new tower has become a familiar symbol to the people, and is a popular destination for field trips by local elementary schools.



## Oil Removal from Alkali Rinse

### Member company

### North American Stainless

### The Challenge

Discharging oily alkali rinse from Grind and Polish Line directly to wastewater treatment

### Why?

The Grind and Polish line generates alkaline wash that mixed with solids, emulsions, and free oil. This alkali rinse is discharged directly to wastewater treatment where oil is visible and difficult to control as no oil sheen is allowed by

regulators.

### Needed action

A trial was conducted to determine if the alkaline wash could be reused by oil separation and a series of membranes to reduce the quantity of waste discharged for treatment.

### Action review

*Specific:* The trial consisted of a small holding tank, a rope skimmer, and two stages of membrane filtrations to include ultrafiltration and reverse osmosis.

*Measurable:* Trials were conducted.

The materials recovered were collected and analysed for various parameters to determine the quality for reuse at the Grind and Polish line. The conductivity was reduced to 27 microsiemens per cubic meter.

*Achievable:* The trial results indicated that the detergent was removed by the treatment, but the alkalinity remained in the water dedicated for reuse. The waste stream was mostly oils and solids which made up approximately 3% of the original volume. The remaining water could be reused for cooling tower make up or make up water for the alkali rinse.

*Realistic:* Reverse osmosis is widely used

for water treatment to obtain pure water for reuse.

*Time-bound:* The trial was completed in the planned time frame. The trial units were readily available.

### Horizontal expansion capability

Yes, this process can be used where there is oil contamination at most water treatment applications around the site.

### Outcome

Fresh water was recovered from heavy oil contaminated water and is suitable for reuse.



## Sustainable Packing Material For Continual Re-use

### Member company

**Bahru Stainless Sdn. Bhd.**

### The Challenge

The packing material is used to provide a certain level of protection to the Finished products and to ensure the Finished products are received in good and acceptable quality. Most of the time the packing material will reach its end of life cycle after the first or second usage phase after which it will be recycled or reprocessed; that will create a certain impact to the environment. In others words, the packing material are not “Re-Used” in a longer sustainable life cycle due to its natural behaviour, design and others reasons.

The strategy to extend the sustainable life cycle of the packing material is developed

to ensure that our packing material can be “Re-Used” in a more economical and sustainable way throughout its life cycle before the packing material enters into the Recycle Process such as reprocess and reproduction.

This strategy starts with the wooden pallets which are usually used for sheet packing. This normal wooden pallet somehow has some disadvantages where it will break after a certain usage period or cycle. It is due to its nature to easily break as the strength of the wooden pallet will reduce over the usage period. The wooden pallet has limited usage once the pallet is broken. Due to this, a new pallet needs to be purchased and this will create excessive logging of trees to produce new pallets.

Replacing the wooden pallets with a sustainable packing material for continuous re-use, is more sustainable.

The oriented strand board is a sustainable packing material. This Oriented Strand Board is made up of recycled wood panels where rectangular wood stands are arranged in cross-oriented layers and bound together with resin. With its ultimate strength and easy for modification for further Re-Used purpose, its will extend the life cycle and create better sustainability strategy.



### Why?

To extend the sustainable life cycle of the packing material so more parties can continually reuse it.



To reduce the excessive logging activities so that can save trees, balance our ecosystem and prevent any natural disaster due to human activities

To support 3R event by developed Oriented Strand Board as a packing material since OSB is made up by recycle wooden waste. Save landfills space by keeping useful materials out.

To reduce packing material costs since OSB is made up by recycle wooden waste and it is cheaper compared to wooden pallet.

To deliver a good quality end sheet product due to the better characteristics of OSB pallet

To reduce the amount of energy and



natural resources needed to produce the packing material.

## Needed action

Use Sustainable Packing Materials for product packaging, that can continuously be re-used in a longer life cycle. Horizontal expansion capability

Yes, since we aim to conserve and preserve our environment by developed Sustainable Packing Material for Continual Reuse, where our next user able to re-use and continue to the next user as well as extend the life cycle.

## Outcome

Health and wellbeing : Increase workers awareness towards important to conserve and preserve environment for future generation, earn new skills and knowledge on how to handle OSB packing material

Business efficiency : The packing material is easy to get thus there's no delay on packing material delivery thus product can deliver to customer on-time

Cost saving : Using OSB can be an affordable option to help the business save money by using packing material made by recycled wood waste

Material quality : Send good quality end sheet product to customer since the OSB characteristics can protect the product shape during the transfer process

Inventory level and sales : Gain trust from potential customers as the product quality as promised and reduce customer claim regarding the unsatisfied packing material quality.



## Using used plastic buckets for cultivating crops

### Member company

**Columbus Stainless**

### The Challenge

A large amount of plastic buckets are disposed of after a refractory installation. Waterproof buckets are used in order to ensure safe storage of critical refractory material. In parallel to this issue of disposal and environmental challenge, Columbus started a pilot scale vegetable garden in order to sponsor an underprivileged community.

### Why?

There is a need in the community for fresh produce, but having fixed structures in the greenhouse posed a problem.



### Needed action

A more sustainable, cost effective and modular solution was needed. Then there was the idea of using the previously disposed plastic buckets and refit them for purpose.

### Horizontal expansion capability

Yes

### Outcome

No disposing of plastic buckets after use. Depending on the amount of refractory relining activities, the plant can generate close to 800 buckets a month. So benefit is twofold: less plastic to land-fill, and they can be reused for something sustainable and cultivate edible crops for the community.

### Other comments

Pictures show the progress. Still in its infancy stage. Eventually plastic buckets will be used only.

Also to note: Used Slab grinding abrasive wheels (see project for land stabilisation also) and wooden pallets used for stillages to support plastic buckets. So all these items were previously disposed of, thus showing the impact of reuse/recycling.



## Using Used Slab Grinding Wheels for land stabilisation

Member company

**Columbus Stainless**

### The Challenge

Erosion during heavy rains

### Why?

Prevent mud/soil washing into storm water drains, and prevent erosion of walls over time.



### Needed action

The team used slab grinding abrasive wheels which would have been sent to landfill site to stabilise the wall and grow vegetation.



### Horizontal expansion capability

Yes

### Outcome

Cost = no landfill + prevented use of precast structures available in the market. Erosion was limited as long-term application has proven. Also, green vegetation does create a more pleasant aesthetic appearance for the workplace environment.



## Equipment to recover soap used as lubricant in stainless steel drawing.

Member company

**INOXFIL S.A.U**

### The Challenge

Reduce the consumption of drawing dry soaps, calcium and sodium stearates, used in the drawing of stainless steel.

### Why?

Due to the amount of dry soap that is thrown away as waste and we consider that with a contaminant elimination process it can continue to be used.

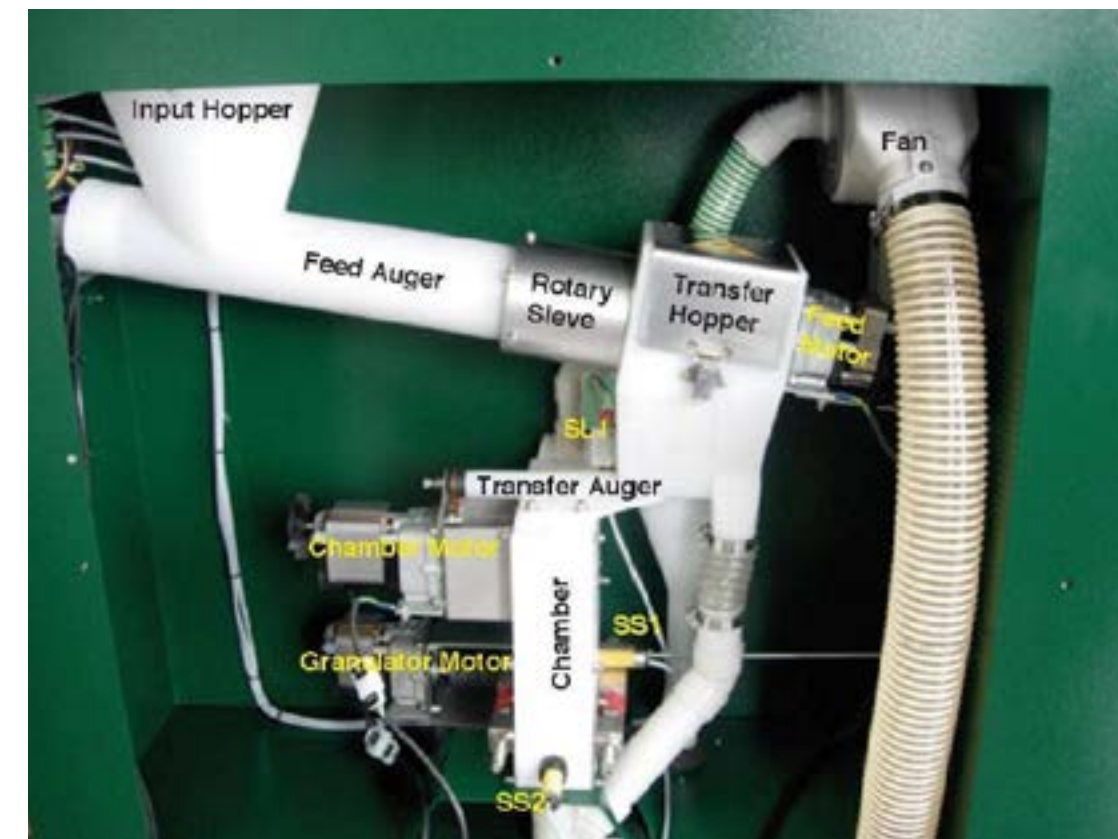

### Needed action

Search for a equipment that allows us to eliminate the contaminants present in the soap, basically magnetic contaminants, oxides and burnt soap, being able to recover up to 50% of the used soap.

### Action review

*Specific:* Contact the company ENVIROTEC Purification System, manufacturer of prototype equipment for the recovery of drawing dry soaps.

*Measurable:* Before the installation of the equipment, all the used dry soap from the wire drawing operation was discarded as waste and nothing was recovered.

*Achievable:* We intend to recover approximately 50% of the dry soap used in the wire drawing operation, multi step drawing

*Realistic:* We are currently recovering around 25% of the used dry soap.

*Time-bound:* The recovery of used dry



soap is being a success and we are within the estimated deadlines.

### Outcome

Recovery of 25% of the dry soap used in drawing. Savings on the purchase of new soap. Waste reduction.



## Reduction of environmental pollution in external areas of Steel Plant

### Member company

**ACERINOX EUROPA, S.A.U.**

### The Challenge

Reduction of environmental pollution in the external areas of the factory and its impact on the environment.

### Why?

ACERINOX EUROPA is a great reference in the industrial sector and, in turn, a model company in the European framework in environmental matters. The sustainability plan "Positive Impact 360°" includes among the 5 strategic pillars of its structure, a specific one aimed for the Climate Change mitigation. ACERINOX EUROPA, in its commitment to this plan, promotes and supports initiatives for a better environment condition. Respect for the

environment is one of its priorities, making it an example of a sustainable industry committed to fight against climate change and overexploitation of scarce resources.

For this reason, the Environmental Section of ACERINOX EUROPA, has made a significant effort to find different solutions, that combined to minimize the air pollution in the external areas of the Melting Shop. At the same time, the PM10 particles will be reduced improving people's health. The project is aligned with the SDG - Sustainable Development Goals.

### Needed action

The problem to solve: minimize the number of suspended particles that can become airborne.

Actions to solve the problem :

1. To use waste water as process water

and auxiliary processes: « street cleaning program» and «sustainable nebulization program».

2. To design and install dust retention systems, according with particles sizes and the prevailing winds in the area.
3. Installing an air quality measurement system in the area, in order to be able to evaluate the effectiveness of the actions carried out to solve the problem.

### Action review

*Specific:* Actions to solve the problem :

1. To use waste water as process water and auxiliary processes, such as,
  - Cleaning streets and yards with irrigation truck. This action reduces diffuse emissions from

raw material handling.



Image 1. Irrigation truck.

- Water nebulizer. The waste water poured into the nebulizer is reused to retain the pollution.





Image 2. Nebulizer.

2. To design and install dust retention

screens, according with particles sizes and the prevailing winds in the area.



Image 3. Environmental dust retention screens.

3. Closing ceiling aerators in the steel plant warehouse, preventing dust from escaping through the aerators to the outside of the steel plant and force the dust to be redirected to the exhaust

systems located in the canopies, increasing dust collection through the “filter dust”.



Image 4. Closing ceiling aerators in Steel Plant.

4. Installing an air quality measurement station in the area, in order to measure the concentration of particles in real time, wind direction, wind

speed, sample collection for particle characterization, etc.



Image 5. Air quality measurement station.



### *Measurable:*

- Reducing the number of particles emitted into the air and decreasing consumption in water intake.
- Air quality measurement station. This action is mandatory in this project, since if it is not measured, we cannot evaluate the other implemented actions.

*Achievable:* The main objective of the reduction of environmental pollution in the external areas of the factory and the impact on the environment, minimizing the number of suspended particles that can become airborne, has been achieved.

In addition, the following benefits have been obtained:

- To reduce the consumption of water, using waste water after treatment in

neutralization plant, avoiding the dump into the marine environment.

- To increase the collection of dust in bag houses from the exhaust system, increasing the amount of melting dust to prepare briquettes or to recovery the metal (oxide reduction), in order to consume it again in the steel plant, promoting a circular economy.

*Realistic:* All actions have been possible to execute:

- New nebulizer is installed to retain suspended particles. INSTALLED.
- Ceiling aerators have been closed. DONE.
- Dust retention screens. INSTALLED.
- Irrigation truck. IN OPERATION.
- Air quality measurement station. INSTALLED.

*Time-bound:* Although some actions, like closing ceiling aerators, dust retention screens and air quality measurement station need time (construction and delivery time in the case of the station), all the actions have been completed within the original time frame.

### **Horizontal expansion capability**

The actions can be expanded within our company and applied within other member companies. The necessary technology is on the market.

ACERINOX EUROPA has in turn shared these actions with the environmental authorities.



## Outcome

- 2023 dust collection in bag houses from exhaust systems has increased in 28,8%, based on 2022.
- Estimated water savings of 800 cubic meters per week.
- Diffuse emissions from traffic, dust produced by material handling and pre-treatment of raw materials, by Steel Plant process have been reduced in an important way, not only generating an environmental improvement but also improving people's well-being
- Number of warning by pollution of suspended particles that can become airborne, have been reduced by 65 percent, based on 2022.

Evolution of atmospheric incident warnings in Melting Shop

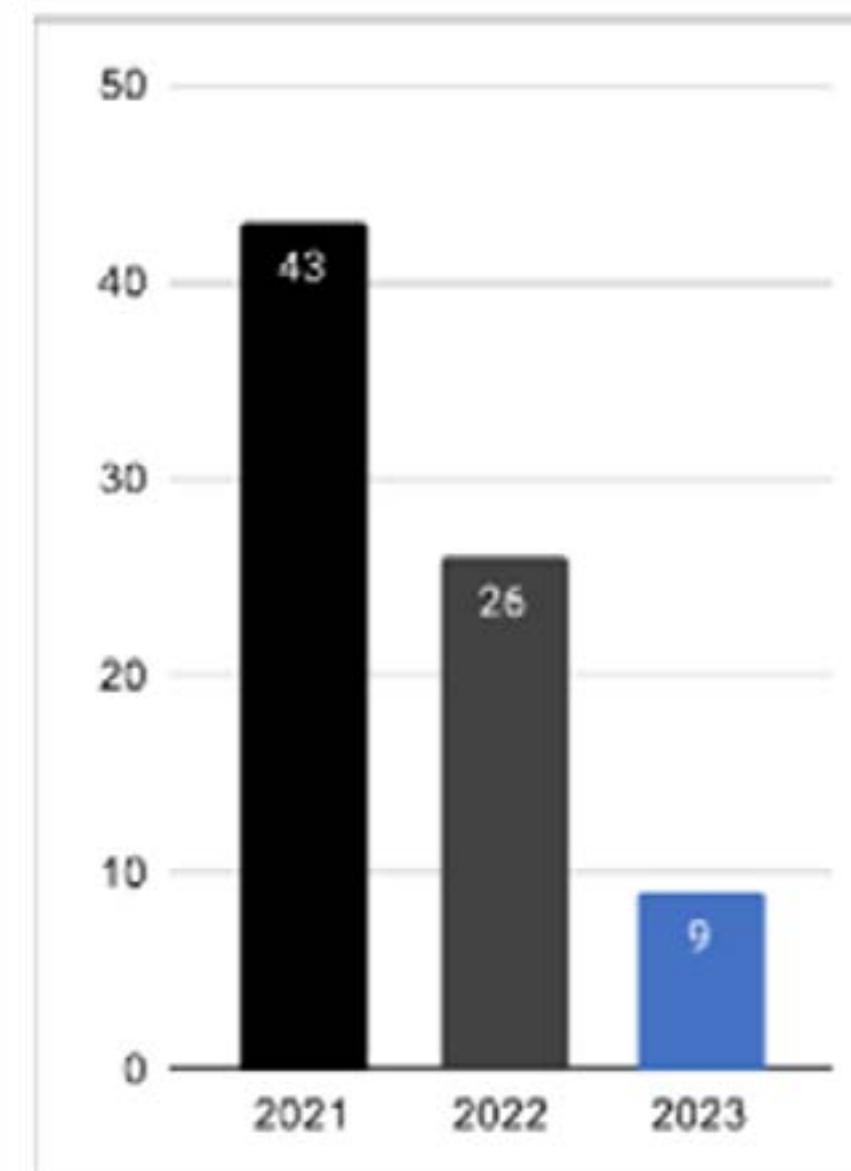

Atmospheric incidents in the melting shop external area means: number of visual cases of dust, in turn confirmed by the real-time data provided by the air quality measurement station. Being the maximum limit allowed 50  $\mu\text{g}/\text{m}^3$ .

## Other comments

The execution of this project concludes that it is possible to achieve objective 0 environmental incidents related with suspended particles, with a plan to undertake the acquisition of new nebulizers and additional dust retention screens that will be placed in other locations likely to generate suspended particles, improving people's well-being.



## Help

- ? Help page
- ☰ Contents page
- < Previous page
- > Next page
- BACK Previous view

## About worldstainless

worldstainless is a not-for-profit research and development association which was founded in 1996 as the International Stainless Steel Forum.

Its primary roles are to undertake stainless steel industry beneficial tasks that are better coordinated centrally in the fields of

- Promoting industry and material sustainability benefits
- Conserving resources and promoting the circular economy
- Providing economic and industry-leading statistics
- Support industry health & safety needs and developments
- Outlining market development and expansion opportunities
- Maintaining brand reputational positioning
- Materials education

## Contact

You can contact the worldstainless team through the following email address:

[info@worldstainless.org](mailto:info@worldstainless.org)

## Disclaimer

The world stainless association believes that the information presented is technically correct. However, worldstainless, its members, staff and consultants specifically disclaim any and all liability or responsibility of any kind for loss, damage, or injury resulting from the use of the information contained in this brochure.





world stainless association

Avenue de Tervueren 270  
1150 Brussels  
Belgium

T: +32 (0) 2 702 89 00  
F: +32 (0) 2 702 88 99  
E: [info@worldstainless.org](mailto:info@worldstainless.org)

C413 Office Building  
Beijing Lufthansa Center  
50 Liangmaqiao Road  
Chaoyang District  
Beijing 100125  
China

T : +86 10 6464 6733  
F : +86 10 6468 0728  
E : [china@worldsteel.org](mailto:china@worldsteel.org)

[worldstainless.org](http://worldstainless.org)

